

FARADAY MULTI-POINT SYSTEMS

HEARY BROS., INC. family established 1895

... IS THE FIFTH GENERATION CONTINUING IN THE LIGHTNING PROTECTION FIELD, WE SPECIALIZE IN THE MANUFACTURE OF HIGH QUALITY, UL LISTED MASTER LABEL FARADAY MULTI-POINT LIGHTNING PROTECTION SYSTEMS.

HEARY BROS. LIGHTNING PROTECTION EQUIPMENT IS COMPOSED OF NON-CORROSIVE HIGH QUALITY ALLOY MATERIALS, SPECIALLY DESIGNED FOR THE PURPOSE OF PROTECTION FROM LIGHTNING STRIKES.

UPON REQUEST, WE PROVIDE SPECIFICATIONS AND DRAWINGS ILLUSTRATING THE LAYOUT OF THE LIGHTNING PROTECTION EQUIPMENT. PLEASE SEND A ROOF PLAN SHOWING ALL MECHANICAL EQUIPMENT AND EXTERIOR ELEVATIONS OF THE STRUCTURE, ALSO STATE TYPE OF STRUCTURE SUPPORT – STEEL OR REINFORCED CONCRETE.

WE ARE PROUD OF OUR FAMILY'S MANY YEARS OF EXPERIENCE AND FEEL OUR EXPERTISE CAN BE OF VALUE TO YOU IN PROTECTING YOUR STRUCTURE. A GLOBAL LISTING OF SOME OF OUR LARGER INSTALLATIONS FOLLOWS.

IF WE MAY BE OF SERVICE TO YOU, PLEASE CONTACT OUR OFFICE.

HEARY BROTHERS LIGHTNING PROTECTION CO., INC.
11291 Moore Road, Springville, New York 14141 USA tel: 716-841-6141 toll free: 800-421-6141 fax: 716-941-3828
E-MAIL: sales@hearybros.com **INTERNET SITE:** <http://www.hearybros.com>

**GLOBAL LISTING OF PROPERTIES
PROTECTED BY HEARY BROS. SYSTEMS
(FARADAY SYSTEMS)**

ALABAMA

Airport Traffic Control Tower Dannelly Field Airport - Montgomery
Alabama A & M University West Campus Living/Learning Center - Normal
Alabama Activity Center & Plaza for Retirement Systems of Alabama - Montgomery
Alabama State Docks - Mobile
American Maize Product Co. - Corn Processing Plant - Decatur
Faulkner University Jones Law School Building - Montgomery
Grain Elevators - Tuscaloosa & Claiborne Mobile Infirmary - Mobile
Holy Name of Jesus Hospital - Gadsden Pharmacy Building - Auburn
John J. Sparkman Center for Missile Excellence - Redstone Arsenal
Montgomery County Health Facility - Montgomery
Samford University Fine Arts Center - Homewood

ALASKA

Aircraft Flight Operation Control Facility - Eielson Air Force Base

ARIZONA

Ammunition Storage Igloos - Bellemont
Ammunition Igloo Magazines - Yuma
City Hall Office Tower & Orpheum Theatre - Phoenix
Maintenance Hanger M.C.A.S. - Yuma
Motorola, Inc. Building 101 Addition - Tempe
Operations Building - Fort Huachuca
Proving Grounds United States Naval Observatory - Flagstaff
St. Joseph's Hospital & Medical Center - Phoenix

ARKANSAS

Arkansas Baptist Medical Center - Little Rock
Red Carpet 1 Inn - Little Rock

CALIFORNIA

Edward's Air Force Base Corrosion Control Facility - Edward's A.F.B.
Lawrence Livermore Laboratory - Livermore
Shriners Hospital for Crippled Children Northern CA Unit - Sacramento
State Farm Mutual Auto Insurance Co. - Bakersfield
Vehicle Maintenance Facility - Truckee
Veterans Administration Hospital - La Jolla

CONNECTICUT

American Can Company - Greenwich
Children's Hospital - Hartford
Loctite Corporation Administration, Research & Development Building - Rocky Hill
Montville 400 Bed Community Correctional Center - Montville
Naval Submarine Base Power Plant - Groton
Pitney Bowes Shipping & Weighing Systems - Shelton

DELAWARE

Christiana Hospital Expansion - Newark
Delaware State College Dorms. Dover
Hockessin Library - Hockessin
Morgan Christiana Cafeteria Expansion - Newark
St. Joseph's Church Parish Hall & Rectory - Middletown

DISTRICT OF COLUMBIA

Georgetown University New Research Building - Washington
George Washington University - Basic Science & Paul Himmelfarb Library - Washington
Metro Transit Control Center - Washington
U.S. Naval Conservatory Building 19 & 34 - Washington
World Bank Phase I, II & III - Washington

FLORIDA

Composite Medical Facility - Elgin Air Force Base
First National Bank & Office Building - Punta Gorda
Florida International University Library and Auditorium - Miami
IBM Complex - Boca Raton
Indian River Memorial Hospital - Vero Beach
Naval Air Station - Jacksonville
Police and Fire Department Buildings - Coral Gables
Royal Poinciana Golf Club - Naples
Sentinel Star Newspaper Plant - Alamonte Springs

GEORGIA

Americus-Sumter County Hospital - Americus
Buildings, Grounds, Utilities - Carter Lake
Cosby Station Publix Supermarket - Douglasville
Dwight Eisenhower Veterans Administration Hospital - Fort Gordon
Howard Johnson Motel - Atlanta
Kennestone Hospital - Marietta
Mobile Chemical Company - Covington
North Fire House Station Atlanta International Airport - Atlanta
St. Joseph Hospital Cancer Center - Atlanta
Springdale Towers - Atlanta
Tattnall Memorial Hospital - Riedsville
Travel Lodge Motor Hotel - East Point

IDAHO

Mountain Home A.F.B. Conforming Storage Facility - Mountain Home
Mountain Home A.F.B. Munitions Storage Facility - Mountain Home
RWMC Waste Storage Facility Building 630 & 635 - Idaho Falls
St. Joseph's Hospital - Lewiston

ILLINOIS

Biological Sciences Building Lecture Room Addition - Carbondale
McCormick Place on the Lake Exhibition Center - Chicago
State Farm Mutual - Bloomington

INDIANA

American General Finance HUB Earth Station - Evansville
Dress Regional Airport Traffic Control Tower - Evansville
Wartsila Diesel Project Steel Stack - Mt. Vernon

IOWA

United States Bulk Mail Center - Des Moines

KANSAS

City Of Wichita Housing Project - Wichita

KENTUCKY

Ammunition Washout Facilities - Lexington - Blue Grass Army Depot - Richmond
Central Energy Plant - Fort Campbell
Enlisted Barracks Complex Building A - Fort Campbell
King's Daughters Hospital - Frankfort
Perry County High School - Hazard
Rockcastle Co. High School - Mt. Vernon
University of Kentucky Agricultural Science Building - Lexington

LOUISIANA

St. Jefferson Hospital - Metairie

MAINE

Electrical Power Distribution Systems Upgrade Bldgs. 85 & 103 - NSGA Winter Harbor
Hilton Inn - Bangor
MBNA-New England Office Building - Brunswick
Portsmouth Naval Shipyard Building 357 - Kittery
University of New England Center for Health Sciences - Biddeford
Weather Forecast Office - Portland

MARYLAND

Aircraft Maintenance Facility - Fort George Mead
Chesapeake College Economic Development Center - Wye Mills
Comsat Laboratories - Clarksburg
Frederick Community College - Frederick
John H. Towers Field Hangar Addn. Bldg. 3158 Andrews A.F.B. - Camp Spring
Marietta Office Corporation - Bethesda
National Naval Medical Ctr. - Bethesda
National Institute of Health William H. Natcher Building - Bethesda
Naval Air Station-Propulsion System Evaluation Facility - Patuxent River
Ocean City Water Treatment Plant - Ocean City
St. Stevens Church - Timonium
University of Maryland Homer Gudelsky Inpatient Bldg. - Baltimore
Warner Bros. Retail Distribution Center - Baltimore
World Trade Center - Baltimore

MASSACHUSETTS

Attleboro Middle Schools (Oak Hill & Studley) - Attleboro
Andrew Jackson Horace Mann School - Allston
Bose Corporation - Framingham
Chestnut Park Towers - Springfield
Hastings-Mallory School - Boston
Internal Revenue Service Center - Andover
Leisure Towers - Lynn
MBTA Police Headquarters - Boston
M.I.T. Lincoln Lab-South Lab. - Lexington
Malden Government Center - Malden
Northeastern University Classroom Addition - Boston
Plymouth Co. Correctional Facility - Plymouth
Quinsigamond Elementary School - Worcester
Southwest Campus High School - Boston
Taunton Wastewater Facility - Taunton
United States Bulk Mail Center - Springfield
United States Courthouse - Boston
University of Massachusetts Medical School - Wooster

MICHIGAN

Henry Ford Hospital - Detroit
Kelly Services Building - Troy
Library - Saline
Michigan Tech. Univ. Elec. Engr. Bldg. phase II- Houghton
Monroe Auto Equipment Company - World Headquarters Office - Monroe
Oaklawn Hospital - Marshall
Vehicle Maintenance Facility-D.P.S. Facility - Birmingham

MINNESOTA

Duluth International Airport - Duluth
Heating Plant - Hibbing
St. Olaf Hospital - Austin

MISSISSIPPI

All State Insurance Company Regional Operations Center Renov. - Jackson
Forrest General Hospital - Hattiesburg
General Services Administration Building-US Army Corps of Engineers - Vicksburg
Le Blanc III Marina and Residence - Louise
VA Medical Center-Nursing Home Building - Jackson

NEBRASKA

Methodist Church - North Platte
Waste Water Treatment Plant Improvements-Administration Bldg. - Kearney

NEW JERSEY

Fairleigh Dickinson School of Dentistry - Hackensack
Gateway I & II Office Buildings - Newark
Jasna Polana J. S. Johnson Residence - Princeton
Rahway Sewage Treatment Plant - Rahway
Rutgers Medical School of New Jersey - North Brunswick
St. Peter's Hospital - Woodbridge
State of New Jersey College of Medicine & Dentistry Library & Science - Newark

NEW MEXICO

Administration Building San Juan County - Aztec
Hi Velocity Test Track - Holloman Air Force Base
Medical Towers - Albuquerque
Multi Purpose Service Center and Alto Park Pool - City of Santa Fe
Solar Observatory Facility - Holloman Air Force Base - Alamogordo
University of New Mexico Learning Resource Center - Tome
White Sands Missile Range - White Sands

NEW YORK

All State Insurance Company - Perinton
Airco-Speer Carbon-Graphite Plant- Niagara Falls
Albany South Mall - Albany
Alfred University Miller Performing Arts Center
Arden Hill Life Care Center - Goshen
Art Park - Lewiston
Broome State School Mental Health Hygiene Facility - Dickenson
Buffalo Sewer Authority Wastewater Treatment Plant Addns. - Squaw Island
Children's Hospital - Buffalo
Catmount Hunt Club - Suffern
Chase Manhattan Bank - Cheektowaga

NEW YORK (CONTINUED)

Chemung Canal Bank - Elmira
Children's Home - Randolph
Circleville Middle School - Circleville
Cornell University Animal Barns - Hartford
Cornell University Dairy Barns - Delhi
Corning Community College - Classroom, Administration,
Science & Amphitheater Bldg. - Corning
E.E. Evendon Estate - Hamburg
Erie County Comprehensive Center - Buffalo
F. A. A. Control Tower - Utica
Goodman Gardens Nursing Home - Rochester
Griffiss Air Force Base - Rome
Harpur College Physical Science Building - Binghamton
Hauppauge- Ronkoma Recreation Center - Hauppauge, Long Island
Hobart William Smith College - Library & Classroom - Geneva
Hofstra College - Long Island
Hooker Chemical and Plastics Corporation - Niagara Falls
Laser Fusion Laboratory - Rochester
Lincoln Towers - Syracuse
Master School - Dobbs Ferry
Middletown Park Manor Nursing Home Addition - Middletown
Newark-Wayne Hospital - Newark
Onadaga Civic Center - Syracuse
Ontario County Health Center - Hopewell
Rehabilitation Center - Central Islip
Rochester Rotary Sunshine Camp - Rochester
Rockefeller Plaza - New York City
Roswell Park Cancer Cell Research Center - Buffalo
Sarah Lawrence Library - Bronxville
School of Advanced Technology - Binghamton
St. Rita's Home Complex - Getzville
State Office Building - Binghamton
Suffolk Community Center - Riverhead, Long Island
Suffolk Community College - Southampton, Long Island
SUNY Colleges at Albany, Buffalo, Binghamton, Oswego, Syracuse, Stoneybrook Convention Center
- Niagara Falls
Tioga Park Raceway Grandstand - Nichols
Toomey-Abbott Apartments - Syracuse
Torrax Pollution Control Center - Orchard Park
United States Courthouse - White Plains
V.A. Nursing Home - Batavia
WCA Hospital - Jamestown
West Point Military Academy - West Point
Wilton State School - Wilton
Over 60,000 Farm and Residential Installations in our State of New York

NORTH CAROLINA

Duke Power and Office Building - Durham
Duke University Communication Center - Library, Medical Science Bldgs. - Durham
Durham Regional Hospital - Durham
Marion Correctional Facility (Fence Grounding) - Marion
Medical/Dental Clinic - Jacksonville
Parachute and Survival Equipment Shop - Camp Le June
Pasquotank Youth Institute - Elizabeth City
University of North Carolina Hospital Administrative Office Building - Chapel Hill
Weyerhaeuser Company New Addition - Elkin

OHIO

Alexander Graham Bell School - Cleveland
Alliance High School - Alliance
Cincinnati Credit Office Building - Cincinnati
Cleveland Indians Baseball Stadium - Cleveland
Defense Construction Supply Center - Columbus
Distribution Center Victoria's Secret - Reynoldsburg
Evangelical Deaconess Hospital - Cleveland
First Federal Bank Building - Toledo
Federal Correctional Institute - Elkton
Guernsey Co. Law Enforcement Center - Cambridge
Guernsey Memorial Hospital - Cambridge
Knickerbocker High Rise - Bay Village
Linden Park Learning Center - Columbus
Mead Towers and Dayton Power and Light - Dayton
Northwestern Ohio University Computer Ctr. - Perrysburg
Ohio State University Hall and Office - Columbus
Park Towers - Cleveland
Riverside Hospital - Toledo
Riverside Hospital - Toledo
Salt Fork State Park Lodge, Motel and Pro Shop - Guernsey Co.
St. Joseph's Church, Rectory, Convent and School - Ashtabula
Thatcher Manufacturing Plant - Toledo
United States Army Ammo Plant - Ravenna

OKLAHOMA

Aircraft Engine Fuel Station - Tinker Air. Force Base
Brockway Glass Manufacturing Plant - Ada
Noble Research Center Phase D - Stillwater

PENNSYLVANIA

Albion Correctional Institute - Albion
California State College - California
Carnegie Library - Pittsburgh
Clarion Mens Dormitory - Clarion
Crawford Co. Correctional Facility - Saegertown Borough
Dam Operations Building - Tioga-Hammond Lakes, Tioga
Daniel Boone Homestead - Birdsboro
Eastern Distribution Systems - New Cumberland
Edinboro College - Edinboro
Extended Care Facility - Washington
G. S. A. - Harrisburg
Lehigh County Prison - Allenwood
Lumbermans Museum - Coudersport
Mellon Bank, State Street Bank, Peach Street Bank - Erie
Penn Lincoln Elementary School - Altoona
Philadelphia Mint - Philadelphia
Professional Quadrangle Building - For University of Pittsburgh
Quaker State Oil - Oil City
Samuel Langley School - Pittsburgh
Schaeffer Brewery - Allentown
South Allegheny Community College - South Allegheny
South Hill Health Center - Jefferson Borough
Spencer Hospital - Meadville
St. Vincent Hospital - Erie

PENNSYLVANIA (CONTINUED)

State Correctional Institution Medium Security Prison - Clearfield
United States Post Office Bulk Mail Center - Pittsburgh
United States Post Office Bulk Mail Facility - Warrendale
Over 7,100 Farms and Residential Installation

RHODE ISLAND

Air Pollution Control System & Shredder Facility - Municipal Incinerator - Pawtucket East
Brown University Science Building - Providence
Charles Place Housing for Elderly - Providence
Huntington Towers - Providence
Johnson Wales University Dormitory - Providence
New Rhode Island Trust Office Building - Providence
Providence Water Pollution Control Plant - East Providence
Rhode Island Nursing Care Center - Providence
T.F. Green State Airport Terminal Improvements - Warwick
Woonsocket Regional Waste Facility - Woonsocket

SOUTH CAROLINA

Apartment Building of University of South Carolina - Columbia
Estill High School Gym/Music Complex - Estill
Grande Ocean Resort Central Facility Building - Hilton Head Island
Litchfield Retreat - North Litchfield Beach
Medical University of South Carolina Business Service Building - Charleston
Oconee Co. Hospital - Seneca
Security Residence Midlands Center - Columbia
United States Charleston Naval Hospital - Charleston Heights
University of South Carolina Music Building - Columbia
William Brice School of Nursing - Columbia
Winn-Dixie Stores - Columbia

TENNESSEE

Hampton Inn - Bristol
Heavy Ion Facility - Oakridge
Metal Recycling Plant - Jackson
Page High School Addition - Williamson Co.
V.A. Medical Center Addition - Nashville
Volunteer State University College Maintenance Building - Gallatin

TEXAS

300 Man Bachelor Quarters - Fort Sam Houston
Animal Research Center - Austin
Brownwood Community Co. Hospital - Brownwood
Hardin-Simmons University Library - Abilene
Hemphill Co. Hospital - Canadian
Hillcrest Doctors Office Building - Waco
Lone Star Army Plant - Texarkana
McDonald Observatory - Fort Davis
MCI Integration Lab - Richardson
New Malon-Hogan Clinic - Big Springs
Physical Plant Facility University of Houston - Clear Lake
Texas Tech. University of Medicine - Lubbock
Weapons Assembly AEC Plantex - Amarillo

VERMONT

Middlebury College Renov. of Milliken, Hadley & Kelly-Lang Residence Halls - Middlebury
Naval Reserve Center - White River Junction
Veterans Administration 240 Bed Hospital - White River Junction

VIRGINIA

Chesapeake General Hospital - Chesapeake
Consolidated Laboratory - Richmond
Dulles International Airport MCI Hangar Addition - Gravelly Point
Dulles International Airport Air Cargo Building #5 Federal Express Addition - Chantilly
Geico Fredericksburg Office Building - Hartwood
Germanna Community College - Fredericksburg
Radford Army Ammunition Plt. - Radford
Rockwell International - Chantilly
United States Court House - Roanoke
Washington National Airport New Terminal Building - Gravelly Point

WEST VIRGINIA

APS Harrison Power Plant - Shinnston
AT&T International Lenox Earth Station Addition - Allbright
Blennerhassett School - Parkersburg
FBI Center - Clarksburg
Federal Building & Courthouse - Charleston
One Valley Square Office Building - Charleston
Raleigh General Hospital SICU/CCU - Berkley
Shepherd College - Shepherdstown
U.S. Fish & Wildlife Service National Education & Training Ctr. - Shepardstown
West Liberty State College Twin Towers - West Liberty
Wheeling Hospital - Wheeling
Wheeling Park High School - Wheeling

WISCONSIN

Gen. Mitchell International Airport Upgrade Base Fuels Complex - Milwaukee
LaCrosse Co. Law Enforcement Center - LaCrosse
Stoughton Senior High School - Stoughton
University of Wisconsin Foundation Office Building Project - Madison

INTERNATIONAL

Ahmadu Bello University Extension - Zaria, Nigeria
Cooling Tower - Smithfield, Australia
Cooling Tower - Trinidad, West Indies
Cooling Tower-Abbott Laboratories - Puerto Rico
Haile Sellassie University Complex - University College Alemaya - Addis Ababa - Ethiopia Youth
Hostels - Jeddah, Dammam and Riyadh - Saudi Arabia
Manufacturing Facilities at Dhahran - Saudi Arabia
Peace Vector II Main Operating Base Upgrade - Sakara, Egypt
Taiwan Power Company-Flue Gas Desulfurization Plant - Linkou, Taiwan
U.S. Embassy Office Building - Caracas, Venezuela
VA Medical Center-Outpatient Clinic Addition - San Juan, Puerto Rico



HEARY BROS.

LIGHTNING PROTECTION CO.,INC.

FARADAY MULTI-POINT SYSTEM TABLE OF CONTENTS

COPPER CONDUCTOR	PG. 11
ALUMINUM CONDUCTOR.....	PG. 14
AIR TERMINALS.....	PG. 15
AIR TERMINAL BASES.....	PG. 17
TRIPOD BRACES.....	PG. 29
AIR TERMINAL ACCESSORIES.....	PG. 30
CABLE CONNECTORS.....	PG. 34
BONDING CONNECTORS.....	PG. 40
THRU-ROOF & THRU-WALL CONNECTORS.....	PG. 52
CABLE FASTENERS & ACCESSORIES.....	PG. 57
ACCESSORIES.....	PG. 63
GROUNDING.....	PG. 66
EXOTHERMIC WELDS.....	PG. 72
HEAVY DUTY STACK EQUIPMENT.....	PG. 74

HEARY BROTHERS LIGHTNING PROTECTION CO., INC.
11291 Moore Road, Springville, New York 14141 USA tel: 716-941-6141 toll free: 800-421-6141 fax: 716-941-3628
E-MAIL: sales@hearybros.com **INTERNET SITE:** <http://www.hearybros.com>

Conductors

COPPER CONDUCTORS

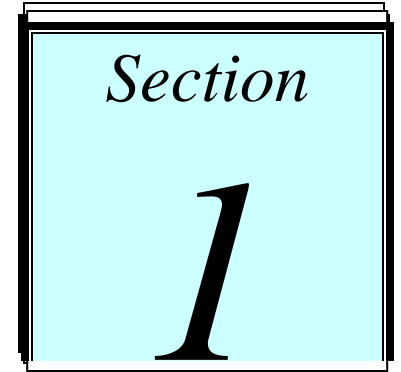

CCHB 29-17

Copper Conductor, 29 strands of 17 gauge, 59,500 circular mils, net weight 190 lbs. per 1000 feet. (1.150mm, 30mm², 278 g/m). Bare Only.



CCHB 32-17

Copper Conductor, 32 strands of 17 gauge, 65,600 circular mils, net weight 215 lbs. per 1000 feet. (1.150mm, 33mm², 320g/m). Bare Only.



CCHB 17-14

Copper Conductor, 17 strands of 14 gauge, 62,000 circular mils, net weight 200 lbs. per 1000 feet. (1.150mm, 32mm², 292g/m). Bare copper.

PCHB 17-14

Same as above, except Corrosion Resistant.



CCHB 24-14

Copper Conductor, 24 strands of 14 gauge, 98,600 circular mils, net weight 328 lbs. per 1,000 feet. (1.628mm, 50mm², 488 g/m). Bare copper.

PCHB 24-14

Same as above, except Corrosion Resistant.



CCHB 28-14

Copper Conductor, 28 strands of 14 gauge, 115,000 circular mils, net weight 375 lbs. per 1,000 feet. (1.628mm, 60mm², 625 g/m).

PCHB 28-14

Same as above, except Corrosion Resistant.

HEARY BROTHERS LIGHTNING PROTECTION CO., INC.
11291 Meore Road, Springville, New York 14141 USA tel: 716-941-6141 toll free: 800-421-6141 fax: 716-941-3628
E-MAIL: sales@hearybros.com **INTERNET SITE:** <http://www.hearybros.com>



CCHB 24-16

Copper Conductor, 24 strands of 16 gauge, 61,900 circular mils, net weight 190 lbs. Per 1,000 feet. (1.291mm, 35mm², 278 g/m).

PCHB 24-16

Same as above, except Corrosion Resistant



CCHB 28-16

Copper Conductor, 28 strands of 16 gauge, 72,500 circular mils, net weight 225 lbs. Per 1,000 feet. (1.291mm, 37mm², 335 g/m).

PCHB 28-16

Same as above, except Corrosion Resistant



CCHB 28-13 (2/0)

Copper Conductor, 28 strands of 13 gauge, 131,500 circular mils, net weight 420 lbs. Per 1,000 feet. (1.628mm, 66mm², 625 g/m).

PCHB 28-13 (2/0)

Same as above, except Corrosion Resistant



CCHB-4X

Copper Conductor Soft Drawn, 41,800 circular mils, net weight 127 lbs. Per 1,000 feet. (21mm², 190 g/m).



CCHB-6

Copper Conductor, 7 strands of 14 gauge, 28,500 circular mils, net weight 92 lbs. Per 1,000 feet. (1.150mm, 14mm², 137 g/m).

HEARY BROTHERS LIGHTNING PROTECTION CO., INC.
11291 Macre Road, Springville, New York 14141 USA tel: 716-941-6141 toll free: 800-421-6141 fax: 716-941-3828
E-MAIL: sales@hearybros.com INTERNET SITE: <http://www.hearybros.com>

COPPER CONDUCTORS



CCHB 480-30

Flat Braided Copper Conductor, 480 strands of 30 gauge, 48,250 circular mils, net weight 195 lbs. Per 1,000 feet (24mm², 290 g/m).

PCHB 480-30

Same as above, except Corrosion Resistant



CCHB 1 1/16

Copper Conductor 1" (25mm) wide x 1/16" (1.6mm) approx. in thickness, 59,000 circular mils, net weight 190 lbs. Per 1,000 feet (30mm², 283 g/m).



CCHB-4/0

Concentric Wound construction with 19 strands of 10 gauge copper wires. Weight 660lbs. Per 1000ft. (2.588mm, 980g/m).

PCHB-4/0

Same as above, except Corrosion Resistant

HEARY BROTHERS LIGHTNING PROTECTION CO., INC.
11291 Meere Road, Springville, New York 14141 USA tel: 716-941-6141 toll free: 800-421-6141 fax: 716-941-3828

E-MAIL: sales@hearybros.com **INTERNET SITE:** <http://www.hearybros.com>

ALUMINUM CONDUCTORS



ACHB 37-13

Aluminum Conductor 37 strands of 13 gauge, 211,600 circular mils, net weight 200 lbs. Per 1,000 feet (1.828mm, 107mm², 298 g/m).



ACHB 28-14

Aluminum Conductor 28 strands of 14 gauge, 57,000 circular mils, net weight 114 lbs. Per 1,000 feet (1.628mm, 58mm², 170 g/m).



ACHB 24-14

Aluminum Conductor 24 strands of 14 gauge, 98,600 circular mils, net weight 110 lbs. Per 1,000 feet (1.628mm, 50mm², 164 g/m).



ACHB-4

Aluminum Conductor 12 strands of 14 gauge, 57,000 circular mils, net weight 58 lbs. Per 1,000 feet (1.628mm, 29mm², 86 g/m).



ACHB- 1 1/16

1" (25mm) wide x 1/16" (1.6mm) approx. thickness, 59,000 circular mils, net weight 73 lbs. Per 1,000 feet (30mm², 109 g/m).

HEARY BROTHERS LIGHTNING PROTECTION CO., INC.
11291 Moore Road, Springville, New York 14141 USA tel: 716-941-6141 toll free: 800-421-6141 fax: 716-941-3628

E-MAIL: sales@hearybros.com **INTERNET SITE:** <http://www.hearybros.com>

Air

Terminals

COPPER AIR TERMINALS

Section

2

Solid Copper 1/2" (13mm) rod with tapered point and threaded end for adapter to air terminal base.

HB-301C	1/2" x 10" (13mm x 250mm)
HB-302C	1/2" x 12" (13mm x 300mm)
HB-303C	1/2" x 18" (13mm x 460mm)
HB-304C	1/2" x 24" (13mm x 600mm)
HB-305C	1/2" x 36" (13mm x 900mm)
HB-306C	1/2" x 48" (13mm x 1200mm)

Solid Copper 3/8" (10mm) rod with tapered point and threaded end for adapter to air terminal base.

HB-307C	3/8" x 10" (10mm x 250mm)
HB-308C	3/8" x 12" (10mm x 300mm)
HB-309C	3/8" x 18" (10mm x 460mm)
HB-310C	3/8" x 24" (10mm x 600mm)
HB-311C	3/8" x 36" (10mm x 900mm)
HB-312C	3/8" x 48" (10mm x 1200mm)

Solid Copper 5/8" (16mm) rod with tapered point and threaded end for adapter to air terminal base.

HB-313C	5/8" x 10" (16mm x 250mm)
HB-314C	5/8" x 12" (16mm x 300mm)
HB-315C	5/8" x 18" (16mm x 460mm)
HB-316C	5/8" x 24" (16mm x 600mm)
HB-317C	5/8" x 36" (16mm x 900mm)
HB-318C	5/8" x 48" (16mm x 1200mm)

- ▶ Corrosion Resistant air terminals available upon request.
- ▶ Longer air terminals available upon request.
- ▶ Blunt pointed air terminals available upon request

HEARY BROTHERS LIGHTNING PROTECTION CO., INC.
11291 Moore Road, Springsville, New York 14141 USA tel: 716-941-6141 toll free: 800-421-6141 fax: 716-941-3628

E-MAIL: sales@hearybros.com **INTERNET SITE:** <http://www.hearybros.com>

ALUMINUM AIR TERMINALS



Solid Aluminum 1/2" (13mm) rod with tapered point and threaded end for adapter to air terminal base.

HB-301A	1/2" x 10" (13mm x 250mm)
HB-302A	1/2" x 12" (13mm x 300mm)
HB-303A	1/2" x 18" (13mm x 460mm)
HB-304A	1/2" x 24" (13mm x 600mm)
HB-305A	1/2" x 36" (13mm x 900mm)
HB-306A	1/2" x 48" (13mm x 1200mm)

Solid Aluminum 5/8" (16mm) rod with tapered point and threaded end for adapter to air terminal base.

HB-313A	5/8" x 10" (16mm x 250mm)
HB-314A	5/8" x 12" (16mm x 300mm)
HB-315A	5/8" x 18" (16mm x 460mm)
HB-316A	5/8" x 24" (16mm x 600mm)
HB-317A	5/8" x 36" (16mm x 900mm)
HB-318A	5/8" x 48" (16mm x 1200mm)

NOTE: 3/8" (10mm) dia. Aluminum air terminal not available. 3/8" (10mm) aluminum rod does not comply with U.L. 96A Lightning Protection Standard.

- ▶ Blunt pointed air terminals available upon request.
- ▶ Longer air terminals available upon request.

HEARY BROTHERS LIGHTNING PROTECTION CO., INC.
11291 Moore Road, Springville, New York 14141 USA tel: 716-941-6141 toll free: 800-421-6141 fax: 716-941-3828
E-MAIL: sales@hearybros.com **INTERNET SITE:** <http://www.hearybros.com>

Air Terminal Bases

Concealed and Adjustable Bases

Section

3



CBHB-8

Concealed thru the Roof Air Terminal Base Assembly

For concealed cable installations. Includes air terminal adapter, ½" (13mm) dia. threaded stainless steel rod, copper bolt pressure-type cable connector and stainless steel mounting hardware.

ABHB-8

Concealed thru the Roof Air Terminal Base Assembly

Same as above except Aluminum cable connector.



CBHB-15

Copper Easy Form Saddle Base

This base is for ridge mounting. Adjustable to fit any ridge. A stamped base, 12" (300mm) long with crimped-type cable connector.
Size: 2" x 12" (50mm x 300mm)

ABHB-15

Aluminum Easy Form Saddle Base

Same as above in Aluminum.

HEARY BROTHERS LIGHTNING PROTECTION CO., INC.
11291 Moore Road, Springville, New York 14141 USA tel: 716-941-6141 toll free: 800-421-6141 fax: 716-941-3628

E-MAIL: sales@hearybros.com **INTERNET SITE:** <http://www.hearybros.com>



CBHB-15X

Copper Adjustable Air Terminal Base

This air terminal Base adjusts to any roof slope and ensures a plumb air terminal. This base can be adhered, nailed, or screwed to the roof. Stamped base with bolt pressure-type cable connector.

Size 2" x 12" (50mm x 300mm)

ABHB-15X

Aluminum Adjustable Air Terminal Base

Same as above in Aluminum.



CBHB-16

Copper Parapet Air Terminal Base

This air terminal base is for mounting on backside of parapet walls. Cast base with bolt pressure-type cable connector and is attached to surface with two anchors.

Size: 2 3/8" x 3 1/8" (60mm x 83mm)

ABHB-16

Aluminum Parapet Air Terminal Base

Same as above in Aluminum.



CBHB-16X

Copper Top Mounted Air Terminal Base

This air terminal base is for mounting to top of parapet walls or chimneys. Cast base with bolt pressure-type cable connector and is attached to mounting surface with two anchors.

Size: 2 3/8" x 3 1/8" (60mm x 83mm)

ABHB-16X

Aluminum Top Mounted Air Terminal Base

Same as above in Aluminum.

HEARY BROTHERS LIGHTNING PROTECTION CO., INC.
11291 Moore Road, Springville, New York 14141 USA tel: 716-941-6141 toll free: 800-421-6141 fax: 716-941-3628
E-MAIL: sales@hearybros.com **INTERNET SITE:** <http://www.hearybros.com>

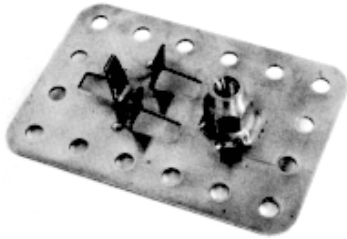

CBHB-17

Copper Adhesive Air Terminal Base

This base is for mounting on flat built-up or rubber membrane roofs and is fastened to roof with an adhesive compound. Stamped base with crimped-type cable connector.

Size: 3 $\frac{3}{4}$ " x 5 $\frac{1}{2}$ " (95mm x 140mm)

ABHB-17

Aluminum Adhesive Air Terminal Base

Same as above in Aluminum.



CBHB-22

Copper Vertical Air Terminal Base

This air terminal base is for vertical connection between point and cable. For mounting on backside of parapets and chimneys. Includes either a masonry anchor or metal screw.

Size: 1" x 5 $\frac{1}{4}$ " (25mm x 131mm)

ABHB-22

Aluminum Adhesive Air Terminal Base

Same as above in Aluminum.



CBHB-23

Copper Adhesive Air Terminal Base

This base is for mounting on built-up or rubber membrane roofs and is fastened to roof with adhesive compound. Cast base with bolt-pressure type cable connector.

Size: 3 $\frac{3}{4}$ " x 5 $\frac{3}{4}$ " (95mm x 145mm)

ABHB-23

Aluminum Adhesive Air Terminal Base

Same as above in Aluminum.

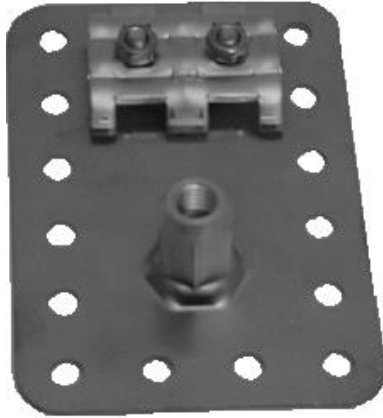

CBHB-23D
Copper Adhesive Air Terminal Base

This base is for mounting on built-up or rubber membrane roofs and is fastened to roof with adhesive compound. Base has bolt-pressure type cable connector.

Size: 3³/₄" x 5¹/₂" (95mm x 140mm)

ABHB-23D
Aluminum Adhesive Air Terminal Base
Same as above in Aluminum.

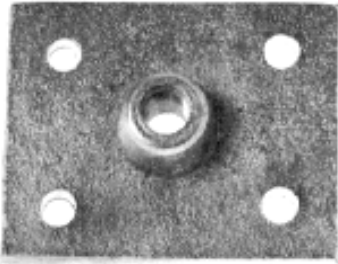

CBHB-23X
Copper Metal Deck Air Terminal Base

8 in² (5160mm²) bronze metal deck base – may be attached directly to metal roof deck with 4 metal stainless steel screws.

Size: 2¹/₂" x 3" (65mm x 80mm)

ABHB-23X
Aluminum Metal Deck Air Terminal Base
Same as above in Aluminum.



CBHB-25
Copper Flat Surface Mounting Air Terminal Base

Cast Bronze base with three anchors for mounting on all types of flat surfaces.

Size: 3¹/₈" (83mm) dia.

ABHB-25
Aluminum Flat Surface Mounting Air Terminal Base
Same as above in Aluminum.



CBHB-32

Copper Offset Parapet Air Terminal Base

Cast bronze heavy duty 1½" (40mm) offset parapet base with bolt pressure-type cable connector. Includes either 2 (two) stainless steel screws or 2 (two) masonry anchors. This base allows for 1½" (40mm) clearance between the air terminal and the mounting surface.

Size: 2¼" x 2½" (60mm x 65mm)

ABHB-32

Aluminum Offset Parapet Air Terminal Base

Same as above in Aluminum.



CBHB-32D

Copper Offset Parapet Air Terminal Base

Copper heavy duty 1½" (40mm) offset parapet base with bolt pressure-type cable connector. Includes either 2 (two) stainless steel screws or 2 (two) masonry anchors. This base allows for 1½" (40mm) clearance between the air terminal and the mounting surface.

Size: 2½" x 3¾" (65mm x 95mm)

ABHB-32D

Aluminum Offset Parapet Air Terminal Base

Same as above in Aluminum.

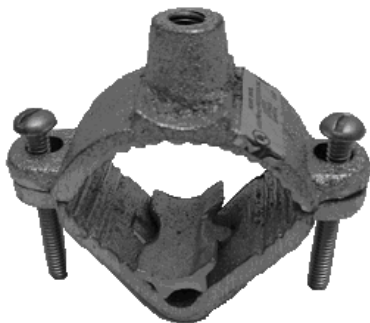

PBHB-33

Corrosion Resistant Copper Pipe Railing Air Terminal Base

Cast base is for use on pipe railing sizes from 1" (25mm) to 2½" (65mm) O.D.

Size: 3" x 3½" (80mm x 90mm)

ABHB-33

Aluminum Pipe Railing Air Terminal Base

Same as above in Aluminum.

HEARY BROTHERS LIGHTNING PROTECTION CO., INC.
11291 Moore Road, Springville, New York 14141 USA tel: 716-941-6141 toll free: 800-421-6141 fax: 716-941-3628
E-MAIL: sales@hearybros.com **INTERNET SITE:** <http://www.hearybros.com>



CBHB-33D
Copper Pipe Railing Air Terminal Base

Copper base is for use on pipe railing sizes from 1" (25mm) to 2½" (65mm) O.D.
Size: 2" x 12" (50mm x 300mm)

ABHB-33D
Aluminum Pipe Railing Air Terminal Base
Same as above in Aluminum.

PBHB-33D
Corrosion Resistant Pipe Railing Air Terminal Base
Same as above in Aluminum.



CBHB-35
Copper Air Terminal Embedded Base

Air Terminal Base of heavy duty design for roof outlet air terminal. Basic use is in poured concrete roof slabs.

ABHB-35
Aluminum Air Terminal Embedded Base

Same as above in Aluminum.

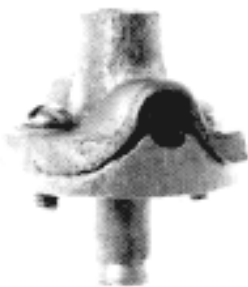

CBHB-38
Copper Top Mount Air Terminal Base

Cast bronze base with bolt pressure-type cable connector for installation on surfaces requiring only one anchor.
Size: 2" (50mm) dia. X 1½" (40mm)

ABHB-38
Aluminum Top Mount Air Terminal Base
Same as above in Aluminum.

HEARY BROTHERS LIGHTNING PROTECTION CO., INC.
11291 Moore Road, Springville, New York 14141 USA tel: 716-941-6141 toll free: 800-421-6141 fax: 716-941-3628
E-MAIL: sales@hearybros.com **INTERNET SITE:** <http://www.hearybros.com>



CBHB-38X

Copper Dome Air Terminal Base

Cast bronze air terminal base designed to fit rounded or domed type structures. Each mounting strap is 5³/₄" (145mm) long.

Size: 2" (50mm) dia. X 1¹/₂" (40mm)

ABHB-38X

Aluminum Dome Air Terminal Base

Same as above in Aluminum.



CBHB-38XX

Copper Air Terminal Pan Type Base

This Air Terminal Base is used on flat roofs where there is a non-affixing surface. The pan base is filled with cement at the site. Cement not included.

Size: 1" x 7¹/₂" (25mm x 193mm)

ABHB-38XX

Aluminum Air Terminal Pan Type Base

Same as above in Aluminum.

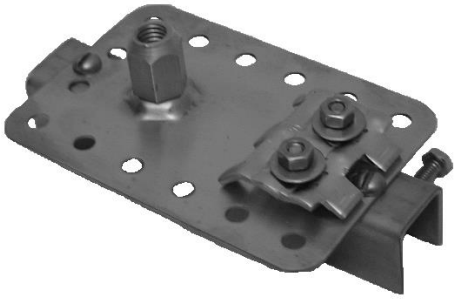

CBHB-59XXD

Copper Standing Seam Air Terminal Base

This air terminal base is for mounting to metal standing seam roofs. Base is rigidly attached to standing seam with 2 (two) stainless steel set bolts. This mounting method eliminates penetrating the metal roof. Bolt pressure-type cable connector.

Size: 2" x 3³/₄" (50mm x 95mm)

ABHB-59XXD

Aluminum Standing Seam Air Terminal Base

Same as above in Aluminum.

PBHB-59XXD

Corrosion Resistant Standing Seam Air Terminal Base

Same as above in Corrosion Resistant.

CBHB-152

Heavy Duty Top Mount Air Terminal Base

Bronze air terminal base for top mounting, 4-way bolt pressure-type cable connector, with threaded stud.



ABHB-152

Heavy Duty Top Mount Air Terminal Base

Same as above in Aluminum.

PBHB-152

Heavy Duty Top Mount Air Terminal Base

Same as above in Corrosion Resistant.

CBHB-153

Heavy Duty Top Mount Air Terminal Base

Bronze air terminal base for top mounting, 4-way bolt pressure-type cable connector, with masonry anchor.



ABHB-153

Heavy Duty Top Mount Air Terminal Base

Same as above except in Aluminum.

PBHB-153

Heavy Duty Top Mount Air Terminal Base

Same as above in Corrosion Resistant.

HEARY BROTHERS LIGHTNING PROTECTION CO., INC.
11291 Moore Road, Springville, New York 14141 USA tel: 716-941-6141 toll free: 800-421-6141 fax: 716-941-3828
E-MAIL: sales@hearybros.com **INTERNET SITE:** <http://www.hearybros.com>

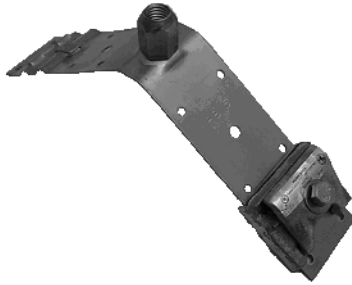

CBHB-170

Copper Saddle Air Terminal Base

Adjustable to fit any ridge. Stamped base with cast bolt pressure-type cable connector. Cable Connector is adjustable so cable can be attached to base at any location along the base leg

Size: 2" x 12" (50mm x 300mm)

ABHB-170

Aluminum Saddle Air Terminal Base

Same as above in Aluminum.



CBHB-172D

Copper Saddle Air Terminal Base

Adjustable to fit any ridge. Stamped base with bolt pressure-type connector.

Size: 2" x 12" (50mm x 300mm)

ABHB-172D

Aluminum Saddle Air Terminal Base

Same as above in Aluminum.



CBHB-170XD

Copper Adjustable Air Terminal Base

This air terminal base adjusts to any roof slope and ensures a plumb air terminal. This base can be adhered, nailed or screwed to the roof. Stamped base with bolt pressure-type cable connector.

Size: 2" x 12" (50mm x 300mm)

ABHB-170XD

Aluminum Adjustable Air Terminal Base

Same as above in Aluminum.

Note: CBHB-170X and ABHB-170X are the same as above except with a cast bolt pressure-type cable connector.

HEARY BROTHERS LIGHTNING PROTECTION CO., INC.
11291 Moore Road, Springville, New York 14141 USA tel: 716-841-6141 toll free: 800-421-6141 fax: 716-941-3628

E-MAIL: sales@hearybros.com **INTERNET SITE:** <http://www.hearybros.com>



CBHB-172

Copper Saddle Air Terminal Base

Adjustable to fit any ridge. Stamped base with cast bolt pressure-type cable connector.

Size: 2" x 12" (50mm x 300mm)

ABHB-172

Aluminum Saddle Air Terminal Base

Same as above in Aluminum.



CBHB-351

Copper Parapet Air Terminal Base

This base is for mounting to backside of parapet walls.

Stamped base with air terminal adapter crimped-type cable connector and 2 (two) stainless steel fasteners.

Size: 2½" x 3¾" (65mm x 95mm)

ABHB-351

Aluminum Parapet Air Terminal Base

Same as above in Aluminum.



CBHB-401

Copper Side Mounted Air Terminal Base

This air terminal base is designed to interconnect horizontal perimeter conductor and vertical download conductor all in one. Cast bronze base with bolt pressure-type cable connector.

ABHB-401

Aluminum Side Mounted Air Terminal Base

Same as above in Aluminum.

HEARY BROTHERS LIGHTNING PROTECTION CO., INC.
11291 Moore Road, Springville, New York 14141 USA tel: 716-841-6141 toll free: 800-421-6141 fax: 716-941-3628
E-MAIL: sales@hearybros.com **INTERNET SITE:** <http://www.hearybros.com>



CBHB-402

Copper Offset Air Terminal Base

This air terminal base is designed to interconnect horizontal perimeter conductor and vertical downlead conductor all in one. This base allows for 2½" (65mm) clearance between the air terminal and the mounting surface. Cast bronze base with bolt pressure-type cable connector.

Size: 2⁵/₈" x 3½" (66mm x 100mm)

ABHB-402

Aluminum Offset Air Terminal Base

Same as above in Aluminum.

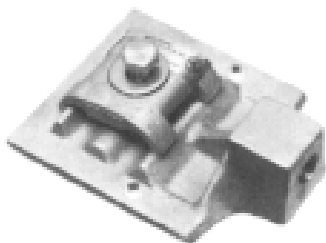

CBHB-403

Copper Side Mount Air Terminal Base

This air terminal base is designed to interconnect horizontal perimeter conductor and vertical downlead conductor all in one. Cast bronze base with bolt pressure-type cable connector.

Size: 3" x 4" (80mm x 100mm)

ABHB-403

Aluminum Side Mount Air Terminal Base

Same as above in Aluminum.



CBHB-404

Copper Side Mount Air Terminal Base with Vertical Cable Connector

This air terminal base is designed with a vertical cable connector. Cable exists bottom of base. Cast bronze base with bolt pressure-type cable connector.

ABHB-404

Aluminum Side Mount Air Terminal Base with Vertical Cable Connector

Same as above in Aluminum

HEARY BROTHERS LIGHTNING PROTECTION CO., INC.
11291 Moore Road, Springsville, New York 14141 USA tel: 716-941-6141 toll free: 800-421-6141 fax: 716-941-3828

E-MAIL: sales@hearybros.com **INTERNET SITE:** <http://www.hearybros.com>



CBHB-406

Copper New Vertical Air Terminal Base

This air terminal base can be used when either a horizontal cable (to interconnect air terminals), or a vertical cable (to interconnect download) is required. Cast bronze bolt pressure-type cable connector.

Size: 1½" x 3⁵/₈" (40mm x 92mm)

ABHB-406

Aluminum New Vertical Air Terminal Base

Same as above in Aluminum.

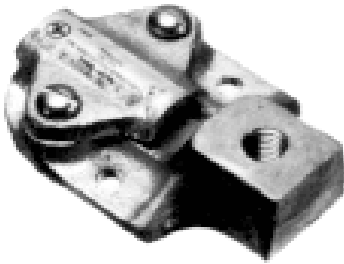

CBHB-407

Copper Top Mount Air Terminal Base

This air terminal base is designed with a "1-way" conductor tap. Used to interconnect air terminal to roof encircling conductor with a single cable tap. Cast bronze bolt pressure-type cable connector.

ABHB-407

Aluminum Top Mount Air Terminal Base

Same as above in Aluminum.

HEARY BROTHERS LIGHTNING PROTECTION CO., INC.
11291 Moore Road, Springville, New York 14141 USA tel: 716-941-6141 toll free: 800-421-6141 fax: 716-941-3828

E-MAIL: sales@hearybros.com **INTERNET SITE:** <http://www.hearybros.com>

Air Terminal Braces

TRIPOD BRACES



Braces are made of ¼" (6mm) tempered steel, hot galvanized after assembly. Feet on braces are annealed to permit shaping to roof.

GSHB 20-14

14" (350mm) Length for 24" (600mm) Point

GSHB 20-24

24" (600mm) Length for 36" (900mm) Point

GSHB 20-36

36" (900mm) Length for 48" (1200mm) Point

GSHB 20-48

48" (1200mm) Length for 60" (1525mm) Point

ADHESIVE –TYPE TRIPOD BRACES



Adhesive (no-nail) galvanized steel tripod brace. After gravel has been removed, feet are cemented in place with adhesive compound.

GSHB 21AB-14

14" (350mm) Length for 24" (600mm) Point

GSHB 21AB-24

24" (600mm) Length for 36" (900mm) Point

GSHB 21AB-36

36" (900mm) Length for 48" (1200mm) Point

GSHB 21AB-48

48" (1200mm) Length for 60" (1525mm) Point

HEARY BROTHERS LIGHTNING PROTECTION CO., INC.
11291 Moore Road, Springville, New York 14141 USA tel: 716-941-6141 toll free: 800-421-6141 fax: 716-941-3628

E-MAIL: sales@hearybros.com

INTERNET SITE: <http://www.hearybros.com>

Air Terminal Accessories

Section

5

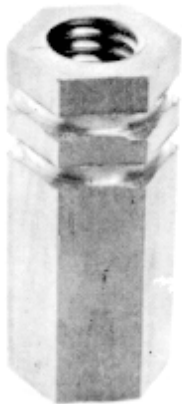

Adaptor for adapting an Air Terminal to a base.

CDHB-18-1

Copper adaptor $\frac{5}{8}$ " (16mm) to $\frac{1}{2}$ " (13mm)

ADHB-18-1

Same as above in Aluminum.

CDHB-18-2

Copper adaptor $\frac{5}{8}$ " (16mm) to $\frac{3}{8}$ " (10mm)

ADHB-18-2

Same as above in Aluminum

CDHB-18-3

Copper adaptor $\frac{1}{2}$ " (13mm) to $\frac{3}{8}$ " (10mm)

ADHB-18-3

Same as above in Aluminum

HEARY BROTHERS LIGHTNING PROTECTION CO., INC.
11291 Moore Road, Springville, New York 14141 USA tel: 716-941-6141 toll free: 800-421-6141 fax: 716-941-3628
E-MAIL: sales@hearybros.com **INTERNET SITE:** <http://www.hearybros.com>



SDHB-19
Spring Adapter

For connection between air terminal and air terminal base. Used in areas where window washing units are employed or where flexibility is required. Spring is of special specification stainless steel.

Size: 7/8" (22mm) x 3 3/4" (95mm)



CSHB-69
Air Terminal Support

To support air terminal or conductor. Cast bronze air terminal support with 1/4" (6mm) dia. X 1" (25mm) long threaded stud.

Size: 1 3/4" x 2" (45mm x 50mm)

► 5/16" (8mm), 3/8" (10mm) and 1/2" (13mm) diameter studs, and longer studs available upon request.

ASHB-69
Same as above in Aluminum

PSHB-69
Same as above in Corrosion Resistant



CDHB-350
Bronze Flexible Swivel Adapter

Adaptable to all air terminal bases. Used in areas where air terminal base is mounted on an angled surface.

ADHB-350
Aluminum Flexible Swivel Adapter
Same as above in Aluminum.

HEARY BROTHERS LIGHTNING PROTECTION CO., INC.
11291 Moore Road, Springville, New York 14141 USA tel: 716-941-6141 toll free: 800-421-6141 fax: 716-941-3628
E-MAIL: sales@hearybros.com **INTERNET SITE:** <http://www.hearybros.com>



CDHB-350D

Copper Flexible Swivel Adapter

Adaptable to all air terminal bases. Used in areas where air terminal base is mounted on an angled surface.

ADHB-350D

Aluminum Flexible Swivel Adapter

Same as above in Aluminum.

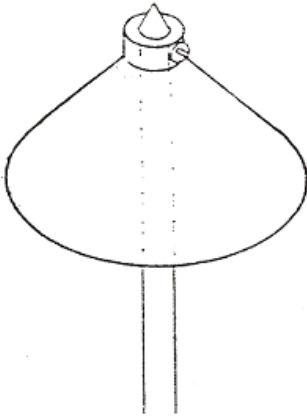

PPO1C

Air Terminal Point Protector

Cast bronze point protector.
Adapts to tip of air terminal.
Size: 3³/₈" (86mm) dia. X 1¹/₂" (40mm)

PPO1A

Air Terminal Point Protector

Same as above in Aluminum.

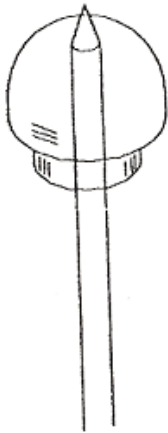

PPO2

Air Terminal Point Protector

Plastic point protector
Adapts to tip of air terminal.
Color: Orange
Size: 2¹/₂" (65mm) dia. x 2¹/₂" (65mm)

HEARY BROTHERS LIGHTNING PROTECTION CO., INC.
11291 Moore Road, Springville, New York 14141 USA tel: 716-941-6141 toll free: 800-421-6141 fax: 716-941-3828
E-MAIL: sales@hearybros.com **INTERNET SITE:** <http://www.hearybros.com>



PPODC

Air Terminal Point Protector

Copper Point Protector

Adapts to tip of air terminal

Size: 2½" (65mm) dia. X 2½" (65mm)

PPODA

Air Terminal Point Protector

Same as above in Aluminum

HEARY BROTHERS LIGHTNING PROTECTION CO., INC.
11291 Moore Road, Springville, New York 14141 USA tel: 716-941-6141 toll free: 800-421-6141 fax: 716-941-3828

E-MAIL: sales@hearybros.com **INTERNET SITE:** <http://www.hearybros.com>

Cable Connectors

Section

6



CRHB-11
Copper Straight Splicer

A stamped crimped-type cable splicer. For Standard copper cable.
Size: 1" x 4" (25mm x 100mm)

ARHB-11
Aluminum Straight Splicer
Same as above in Aluminum.

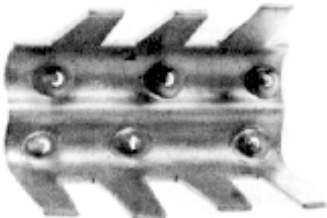

CRHB-12
Copper Twin Cable Splicer

A stamped crimped-type cable splicer. For standard copper cable.
Size: 2½" (65mm) long

ARHB-12
Aluminum Twin Cable Splicer
Same as above in Aluminum.

HEARY BROTHERS LIGHTNING PROTECTION CO., INC.
11291 Moore Road, Springville, New York 14141 USA tel: 716-941-6141 toll free: 800-421-6141 fax: 716-941-3628
E-MAIL: sales@hearybros.com **INTERNET SITE:** <http://www.hearybros.com>

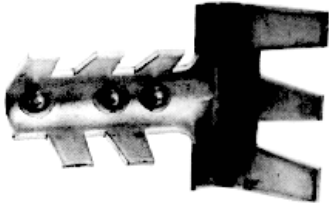

CRHB-14
Copper Tee Cable Splicer

A stamped crimped-type cable splicer. For standard copper cable.
Size: 2" x 3" (50mm x 80mm)

ARHB-14
Aluminum Tee Cable Splicer
Same as above in Aluminum.

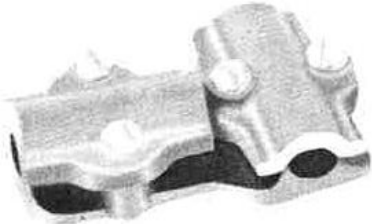

CRHB-14XX
Copper Tee Splicer

A bolt pressure-type cable splicer for branch splicing. For cables through 2/O.
Size: 2" x 3" (50mm x 80mm)

ARHB-14XX
Aluminum Tee Splicer
Same as above in Aluminum



CRHB-26
Copper Heavy Duty Straight Splicer

4 screw bronze sleeve type straight splicer.
Size: 3/4" (20mm) O.D. x 5" (125mm) long

ARHB-26
Aluminum Heavy Duty Straight Splicer
Same as above in Aluminum

HEARY BROTHERS LIGHTNING PROTECTION CO., INC.
11291 Macre Road, Springville, New York 14141 USA tel: 716-841-6141 toll free: 800-421-6141 fax: 716-841-3628
E-MAIL: sales@hearybros.com **INTERNET SITE:** <http://www.hearybros.com>

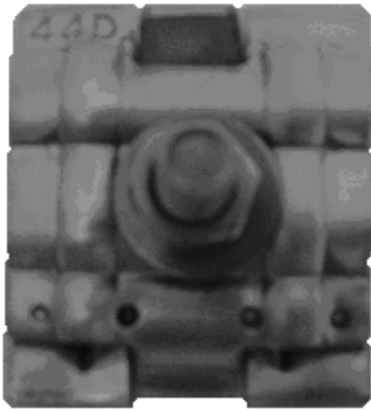
**CNHB-44D**

All Purpose Cable Connector

Copper parallel clamp with 1 (one) bolt pressure-type cable connector. This clamp adjusts to fit all sizes of cable.

Size: 1 $\frac{3}{4}$ " x 2" (45mm x 50mm)

ANHB-44D

All Purpose Cable Connector

Same as above in Aluminum.

**CNHB-44**

All Purpose Cable Connector

Cast bronze parallel clamp with 1 (one) bolt pressure-type cable connector. This clamp adjusts to fit all sizes of cable.

Size: 1" x 1 $\frac{1}{2}$ " (25mm x 40mm)

ANHB-44

All Purpose Cable Connector

Same as above in Aluminum.

**CNHB-52**

Copper Large All Fit Around Clamp

A bronze clamp with 1 $\frac{1}{2}$ " (40mm) of contact to connect all cables through 2/O all round metallic bodies through $\frac{5}{8}$ " (16mm) diameter.

Size: 1 $\frac{5}{8}$ " x 1 $\frac{5}{8}$ " (41mm x 41mm)

ANHB-52

Aluminum Large All Fit Around Clamp

Same as above in Aluminum.

HEARY BROTHERS LIGHTNING PROTECTION CO., INC.
11291 Moore Road, Springville, New York 14141 USA tel: 716-841-6141 toll free: 800-421-6141 fax: 716-941-3628
E-MAIL: sales@hearybros.com **INTERNET SITE:** <http://www.hearybros.com>



CNHB-57
Copper Cable Connector

A bronze parallel clamp with 2 stainless steel bolts and nuts. This clamp is adjustable to fit all sizes of cables. Will also fit all sizes of rods.
Size: 1½" x 2" (40mm x 50mm)

ANHB-57
Aluminum Cable Connector
Same as above in Aluminum.

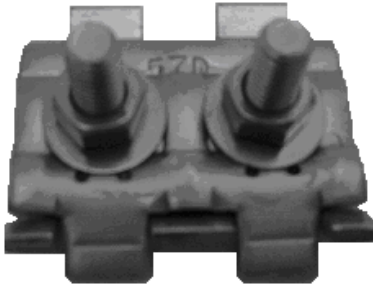

CNHB-57D
Copper Cable Connector

A parallel clamp with 2 stainless steel bolts and nuts. This clamp is adjustable to fit all sizes of cables. Will also fit all sizes of rods.
Size: 1½" x 2" (40mm x 50mm)

ANHB-57D
Aluminum Cable Connector
Same as above in Aluminum.



CNHB-57-4
Copper Cable Connector

A bronze parallel clamp with 4 stainless steel bolts and nuts. This clamp is adjustable to fit all sizes of cables. Will also fit all sizes of rods.
Size: 1½" x 4" (40mm x 100mm)

ANHB-57-4
Aluminum Cable Connector
Same as above in Aluminum.

HEARY BROTHERS LIGHTNING PROTECTION CO., INC.
11291 Moore Road, Springville, New York 14141 USA tel: 716-941-6141 toll free: 800-421-6141 fax: 716-941-3828
E-MAIL: sales@hearybros.com **INTERNET SITE:** <http://www.hearybros.com>



CMHB-57X

Copper Crossover Cable Connector

A cross run clamp, cast bronze with 4 (four) stainless steel screws, for all standard cables through 2/O.

AMHB-57X

Aluminum Crossover Cable Connector

Same as above in Aluminum.



CMHB-57XX

Copper One Bolt Flat Cable Connector

A bronze clamp with 1½" (40mm) of contact to connect all cables through 2/O to flat metallic bodies.

Size: 1½" x 2" (40mm x 50mm)

AMHB-57XX

Aluminum One Bolt Flat Cable Connector

Same as above in Aluminum.



CMHB-57XXD

Copper One Bolt Flat Cable Connector

A copper clamp with 1 ½" (40mm) of contact to connect all cables through 2/O to flat metallic bodies.

Size: 1 ½" x 2" (40mm x 50mm)

AMHB-57XXD

Aluminum One Bolt Flat Cable Connector

Same as above in Aluminum.

HEARY BROTHERS LIGHTNING PROTECTION CO., INC.
11291 Moore Road, Springville, New York 14141 USA tel: 716-841-6141 toll free: 800-421-6141 fax: 716-941-3628
E-MAIL: sales@hearybros.com **INTERNET SITE:** <http://www.hearybros.com>

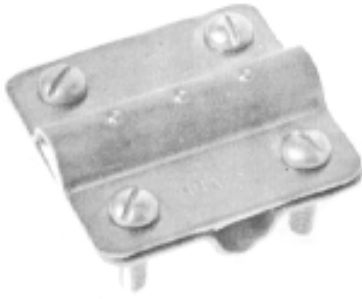

CMHB-57XXX

Stamped Copper Crossover Connector

Stamped copper crossover connector with stainless steel bolt and nut.

AMHB-57XXX

Stamped Aluminum Crossover Connector

Same as above in Aluminum.



MNHB-93

Bimetal Connection

Stainless steel with four stainless steel screws for joining aluminum and copper conductors.

Size: 1" (25mm) O.D. x 4" (100mm) long



CMHB-501

Copper Tee Splicer

Cast bronze cable splicer with bolt pressure-type cable connector. Run and Tap Design.

For conductor sizes thru 2/O.

Size: 3" x 4" (80mm x 100mm)

AMHB-501

Aluminum Tee Splicer

Same as above in Aluminum.

HEARY BROTHERS LIGHTNING PROTECTION CO., INC.
11291 Macre Road, Springville, New York 14141 USA tel: 716-841-6141 toll free: 800-421-6141 fax: 716-841-3628
E-MAIL: sales@hearybros.com **INTERNET SITE:** <http://www.hearybros.com>

Section

7

BONDING CONNECTORS

HEARY BROTHERS LIGHTNING PROTECTION CO., INC.
11291 Moore Road, Springville, New York 14141 USA tel: 716-941-6141 toll free: 800-421-6141 fax: 716-941-3828
E-MAIL: sales@hearybros.com **INTERNET SITE:** <http://www.hearybros.com>

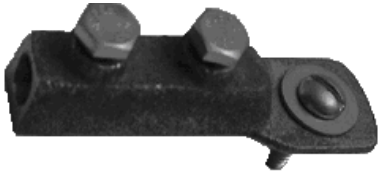

CNHB-42
Bus Terminal Connector

Cast bronze bonding lug for connection to various metal bodies and bus bar. 2 (two) stainless steel bolt pressure-type cable connector.
For secondary conductor.
Size: 1" x 3¼" (25mm x 83mm)

ANHB-42
Bus Terminal Connector
Same as above in Aluminum.



CNHB-42X
Copper Strap Type Pipe Clamp

Copper bonding strap with cast cable connector. Fits metal pipes from 3" (80mm) to 4" (100mm) O.D.
Longer straps available upon request.

ANHB-42X
Aluminum Strap Type Pipe Clamp
Same as above in Aluminum.



CNHB-42XD
Copper Strap Type Pipe Clamp

Copper bonding strap with cable connector. Fits metal pipes from 3" (80mm) to 4" (100mm) O.D.
Longer straps available upon request

ANHB-42XD
Aluminum Strap Type Pipe Clamp
Same as above in Aluminum.

HEARY BROTHERS LIGHTNING PROTECTION CO., INC.
11291 Moore Road, Springville, New York 14141 USA tel: 716-941-6141 toll free: 800-421-6141 fax: 716-941-3828
E-MAIL: sales@hearybros.com **INTERNET SITE:** <http://www.hearybros.com>

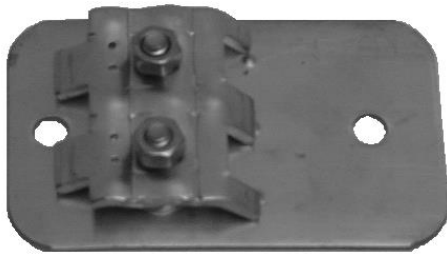

CPHB-54D
Bonding Plate

A 10 sq. in. (6250mm²) bonding plate with bolt pressure-type cable connector. Used for bonding cables to metallic objects such as ACHU, exhaust fans, ventilators, etc. Includes 2 (two) 1/4" x 3/4" (6mm x 20mm) stainless steel metal screws.

Size: 2 1/2" x 4" (63mm x 100mm)

APHB-54D
Bonding Plate

Same as above in Aluminum.

PPHB-54D
Bonding Plate

Same as above in Corrosion Resistant.



CPHB-54
Bonding Plate

A 8 sq. in. (5161mm²) cast bronze bonding plate with bolt pressure-type cable connector. Used for bonding cable to metallic objects such as ACHU, exhaust fans, ventilators, etc. Includes 2 (two) 1/4" x 3/4" (6mm x 20mm) stainless steel metal screws.
Size: 2 3/4" x 3 1/2" (70mm x 90mm)

APHB-54
Bonding Plate

Same as above in Aluminum.

PPHB-54
Bonding Plate

Same as above in Corrosion Resistant

HEARY BROTHERS LIGHTNING PROTECTION CO., INC.
11291 Moore Road, Springville, New York 14141 USA tel: 716-941-6141 toll free: 800-421-6141 fax: 716-941-3828
E-MAIL: sales@hearybros.com INTERNET SITE: <http://www.hearybros.com>



CPHB-54X

Stamped Copper Bonding Plate

A 8 sq. in. (5161mm²) stamped, copper bonding plate with crimped-type cable connector.
Size: 3" x 3½" (80mm x 90mm)

APHB-54X

Stamped Aluminum Bonding Plate

Same as above in Aluminum.

PPHB-54X

Stamped Corrosion Resistant Bonding Plate

Same as above in Corrosion Resistant.

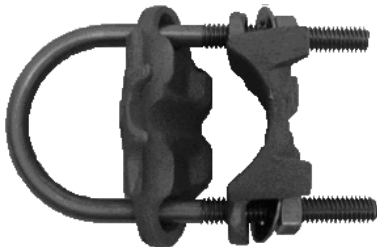

CNHB-55

Copper Pipe Connection

Stainless steel U-bolt with cast cable connector. Fits rods and pipes up to 1½" (30mm) dia.
For larger U-bolt see page 25

ANHB-55

Aluminum Pipe Connection

Same as above in Aluminum

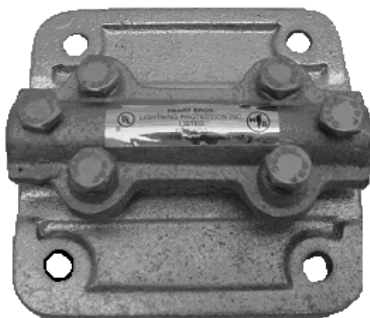

CPHB-56

Heavy Duty Copper Bonding Plate

A heavy duty cast bronze bonding plate for cable through 4/O. Bolt pressure-type cable connector. Includes 4 (four) stainless steel machine screws.
Size: 4" x 4" (100mm x 100mm)

APHB-56

Heavy Duty Aluminum Bonding Plate

Same as above in Aluminum.

PPHB-56

Heavy Duty Corrosion Resistant Bonding Plate

Same as above in Corrosion Resistant.

HEARY BROTHERS LIGHTNING PROTECTION CO., INC.
11291 Moore Road, Springville, New York 14141 USA tel: 716-941-6141 toll free: 800-421-6141 fax: 716-941-3828
E-MAIL: sales@hearybros.com **INTERNET SITE:** <http://www.hearybros.com>

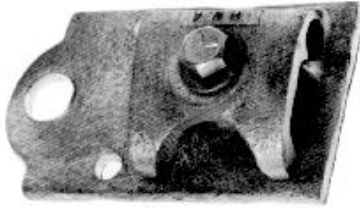

CPHB-58

Copper Bolt Hole Bonding Plate

8 sq. in. (5161mm²) cast bronze bonding plate or bus terminal, with a 1/2" (13mm) hole. Has bolt pressure-type cable connector with 2" (50mm) of contact.
Size: 2 1/2" x 3 1/2" (65mm x 90mm)

APHB-58

Aluminum Bolt Hole Bonding Plate

Same as above in Aluminum.

PPHB-58

Corrosion Resistant Bolt Hole Bonding Plate

Same as above in Corrosion Resistant

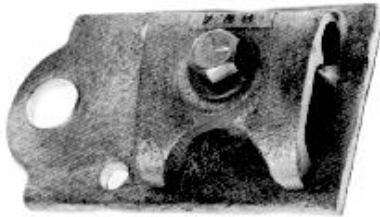

CPHB-58X

Copper Bolt Hole Bonding Plate

Same as above except with a 3/8" (10mm) hole and includes stainless steel hex head bolt, nut and washer.

APHB-58X

Aluminum Bolt Hole Bonding Plate

Same as above in Aluminum.

PPHB-58X

Corrosion Resistant Bolt Hole Bonding Plate

Same as above in Corrosion Resistant.

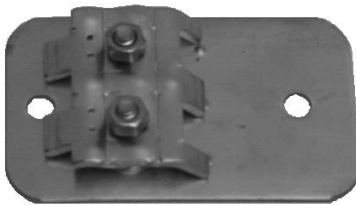

CPHB-58D

Copper Bolt Hole Bonding Plate

A 10 sq. in. (6250mm²) bonding plate with 1/2" (13mm) hole.. Has bolt pressure type cable connector with 2" (50mm) of contact.
Size: 2 1/2" x 4" (63mm x 100mm)

PPHB-58D

Same as above in Corrosion Resistant.

APHB-58D

Same as above in Aluminum.

HEARY BROTHERS LIGHTNING PROTECTION CO., INC.
11291 Moore Road, Springville, New York 14141 USA tel: 716-941-6141 toll free: 800-421-6141 fax: 716-941-3628
E-MAIL: sales@hearybros.com **INTERNET SITE:** <http://www.hearybros.com>

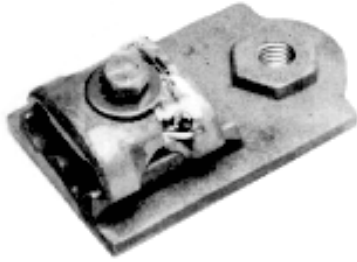

CPHB-58XX

Copper Bolt Hole Bonding Plate with Multi Conductors Connectors

8 sq. in. (5161mm²) cast bronze bonding plate with one tapped hole to accept 1/2" (13mm) threaded rod. Has bolt pressure-type parallel cable connector for multi conductor connection.
Size: 2 1/2" x 3 1/2" (65mm x 90mm)

APHB-58XX

Aluminum Bolt Hole Bonding Plate
Same as above in Aluminum.

PPHB-58XX

Corrosion Resistant Bolt Hole Bonding Plate
Same as above in Corrosion Resistant

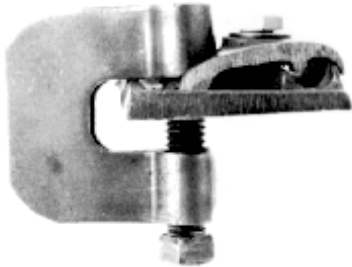

PPHB-59

Copper Bonding Plate with Small C-Clamp

8 sq. in. (5161mm²) Corrosion Resistant cast bronze bonding plate with "C" clamp for cables through 2/O. Used for bonding ladders, flat steel bar and various metal objects up to 1/2" (13mm) thick.
Size: 2 3/8" x 3 3/8" (60mm x 86mm) [bonding plate]

APHB-59

Aluminum Bonding Plate with Small C-Clamp
Same as above in Aluminum.



PPHB-59D

Copper Bonding Plate with Small C-Clamp

8 sq. in. (5161 mm²) Corrosion Resistant bonding plate with "C" clamp for cables through 2/O. Used for bonding ladders, flat steel bar, and various metal objects up to 1/2" (13mm) thick.
Size: 2 3/8" x 3 3/8" (60mm x 86mm) [bonding plate]

APHB-59D

Aluminum Bonding Plate with Small C-Clamp
Same as above in Aluminum.

HEARY BROTHERS LIGHTNING PROTECTION CO., INC.
11291 Macore Road, Springville, New York 14141 USA tel: 716-841-6141 toll free: 800-421-6141 fax: 716-841-3828
E-MAIL: sales@hearybros.com INTERNET SITE: <http://www.hearybros.com>



PPHB-59X

Copper Bonding Plate with C-Clamp

10 sq. in. (6451mm²) Corrosion Resistant cast bronze bonding plate. For bonding to structural steel up to 1½" (40mm) thick. Cast bolt pressure-type cable connector. Fits #2 through 2/O conductor. Size: 2¾" x 3¾" (70mm x 95mm) [bonding plate]

APHB-59X

Aluminum Bonding Plate with C-Clamp

Same as above in Aluminum.



CPHB-59M

Copper Medium Bonding Plate

8 sq. in. (6451mm²) cast bronze bonding plate for cables through 2/O. Used for bonding metal objects up to 1" (25mm) Size: 2¾" x 3½" x 2" (70mm x 90mm x 50mm)

APHB-59M

Aluminum Medium Bonding Plate

Same as above in Aluminum.

PPHB-59M

Corrosion Resistant Medium Bonding Plate

Same as above in Corrosion Resistant



CTHB-69X

Copper Flexible Bonding Strap.

Used for bonding metal fence gates, metal doors to metal door frames. Used in any location where flexible joint is required. Longer straps can be furnished on request.

Size: ¾" (20mm) wide x 12" (300mm) long

ATHB-69X

Aluminum Flexible Bonding Strap

Same as above in Aluminum.

HEARY BROTHERS LIGHTNING PROTECTION CO., INC.

11291 Moore Road, Springville, New York 14141 USA tel: 716-941-6141 toll free: 800-421-6141 fax: 716-941-3828

E-MAIL: sales@hearybros.com **INTERNET SITE:** <http://www.hearybros.com>

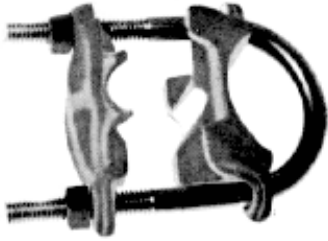

CNHB-91X
Copper Pipe Connection

Stainless steel U-bolt with castable connector.
Fits rods and pipes up to 1 3/4" (45mm) dia.

ANHB-91X
Aluminum Pipe Connection
Same as above in Aluminum.



CMHB-97
Copper Strap Pipe Clamp

An adjustable 2" (50mm) wide, corrosion resistant copper bonding strap with a bronze cast bolt pressure-type cable connector. Fits iron pipe sizes through 4" (100mm) O.D. Longer straps available upon request.

AMHB-97
Aluminum Strap Pipe Clamp
Same as above in Aluminum.



CMHB-97D
Copper Strap Pipe Clamp

An adjustable 2" (50mm) wide, corrosion resistant copper bonding strap with a copper bolt pressure-type cable connector. Fits iron pipe sizes through 4" (100mm) O.D.

Longer straps available upon request.

AMHB-97D
Aluminum Strap Pipe Clamp
Same as above in Aluminum.

HEARY BROTHERS LIGHTNING PROTECTION CO., INC.
11291 Moore Road, Springville, New York 14141 USA tel: 716-941-6141 toll free: 800-421-6141 fax: 716-941-3628
E-MAIL: sales@hearybros.com INTERNET SITE: <http://www.hearybros.com>

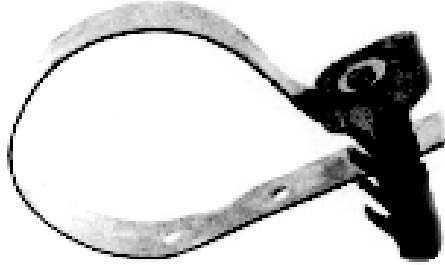

CMHB-97X

Copper Strap Pipe Clamp

An adjustable 1" (25mm) wide, copper bonding strap with crimped-type cable connector. Fits metal pipe sizes through 4" (100mm) O.D.

Longer straps available upon request.

AMHB-97X

Aluminum Strap Pipe Clamp

Same as above in Aluminum.



CMHB-100XD

Copper Strap Pipe Clamp

An adjustable 1" (25mm) wide, copper bonding strap with bolt pressure-type cable connector. Fits metal pipe sizes through 4" (100mm) O.D.

Longer straps available upon request.

AMHB-100XD

Aluminum Strap Pipe Clamp

Same as above in Aluminum.



CMHB-100X

Copper Strap Pipe Clamp

An adjustable 1" (25mm) wide, corrosion resistant copper bonding strap with a cast bolt pressure-type cable connector. Fits iron pipe sizes through 4" (100mm) O.D.

Longer straps available upon request.

AMHB-100X

Aluminum Strap Pipe Clamp

Same as above in Aluminum.

HEARY BROTHERS LIGHTNING PROTECTION CO., INC.
11291 Moore Road, Springville, New York 14141 USA tel: 716-941-6141 toll free: 800-421-6141 fax: 716-941-3628

E-MAIL: sales@hearybros.com **INTERNET SITE:** <http://www.hearybros.com>



CMHB-103

Copper Perfection Pipe Clamp

An adjustable bronze clamp for bonding water pipes, handrails, or other pipes. This is a precision clamp designed to tighten to the pipe and cable simultaneously. Cable attaches parallel to the pipe. Fits pipes from 3/4" to 1 1/2" (20mm x 40mm) O.D. Size: 1 1/2" x 1 3/4" (40mm x 45mm)

PMHB-103

Corrosion Resistant Perfection Pipe Clamp

Same as above in Corrosion Resistant



CMHB-103D

Copper Perfection Pipe Clamp

An adjustable copper clamp for bonding water pipes, handrails, or pipes. Fits pipes from 3/4" to 2 1/2" (20mm x 65mm) O.D.

AMHB-103D

Aluminum Perfection Pipe Clamp

Same as above in Aluminum.

PMHB-103D

Corrosion Resistant Perfection Pipe Clamp

Same as above in Corrosion Resistant.



CNHB-160D

Copper One Bolt Bonding Terminal

Used for bonding drains, door tracks and numerous metal bodies.

Size: 1" x 10" (25mm x 250mm)

ANHB-160D

Aluminum One Bolt Bonding Terminal

Same as above in Aluminum.

HEARY BROTHERS LIGHTNING PROTECTION CO., INC.
11291 Moore Road, Springville, New York 14141 USA tel: 716-941-6141 toll free: 800-421-6141 fax: 716-941-3628

E-MAIL: sales@hearybros.com **INTERNET SITE:** <http://www.hearybros.com>



CMHB-103X

Copper Large Perfection Pipe Clamp

An adjustable bronze clamp for bonding to water pipes, handrails, or other pipes. This is a precision clamp designed to tighten to the pipe and cable simultaneously. Cable attaches parallel to the pipe. Fits iron pipe sizes from 1 $\frac{5}{8}$ " to 2 $\frac{1}{2}$ " (41mm x 65mm) O.D.
Size: 2" x 2" (50mm x 50mm)

PMHB-103X

Corrosion Resistant Perfection Pipe Clamp

Same as above in Corrosion Resistant.

AMHB-103X

Aluminum Perfection Pipe Clamp

Same as above in Aluminum.



CMHB-103XD

Copper Large Perfection Pipe Clamp

An adjustable copper clamp for bonding water pipes, handrails, or other pipes. Fits pipes from 1 $\frac{5}{8}$ " to 2 $\frac{1}{2}$ " (41mm x 65mm) O.D.

AMHB-103XD

Aluminum Large Perfection Pipe Clamp

Same as above in Aluminum.

PMHB-103XD

Corrosion Resistant Large Perfection Pipe Clamp

Same as above in Corrosion Resistant.

HEARY BROTHERS LIGHTNING PROTECTION CO., INC.
11291 Moore Road, Springville, New York 14141 USA tel: 716-941-6141 toll free: 800-421-6141 fax: 716-941-3628
E-MAIL: sales@hearybros.com **INTERNET SITE:** <http://www.hearybros.com>



CNHB-160

Copper One Bolt Stamped Bonding Terminal

Used for bonding roof drains, door tracks, and numerous metal bodies.

Size: 2" x 5½" (50mm x 140mm)

ANHB-160

Aluminum One Bolt Stamped Bonding Terminal

Same as above in Aluminum.



CNHB-160XX

Copper Terminal Lug

Cast copper bonding connector with 1 stainless steel bolt pressure-type cable connector. For interconnecting numerous metal bodies, such as tracks, roof drains, door frames, etc.

Size: 1⅝" x 3⅜" (41mm x 85mm)

ANHB-160XX

Aluminum Terminal Lug

Same as above in Aluminum.

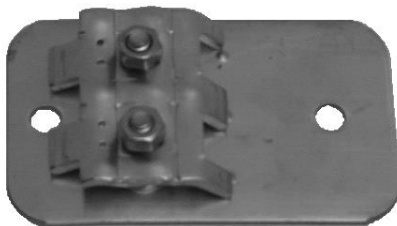

CPHB-58XD

Copper Bolt Hole Bonding Plate

A 10 sq. in. (6250mm²) bonding plate with ⅜" (10mm) hole.. Has bolt pressure type cable connector with 2" (50mm) of contact.

Size: 2½" x 4" (63mm x 100mm)

PPHB-58XD

Same as above in Corrosion Resistant.

APHB-58XD

Same as above in Aluminum.

HEARY BROTHERS LIGHTNING PROTECTION CO., INC.
11291 Moore Road, Springville, New York 14141 USA tel: 716-941-6141 toll free: 800-421-6141 fax: 716-941-3628
E-MAIL: sales@hearybros.com **INTERNET SITE:** <http://www.hearybros.com>

Section

8

THRU-ROOF AND THRU-WALL CONNECTORS

HEARY BROTHERS LIGHTNING PROTECTION CO., INC.
11291 Moore Road, Springville, New York 14141 USA tel: 716-941-6141 toll free: 800-421-6141 fax: 716-941-3628
E-MAIL: sales@hearybros.com **INTERNET SITE:** <http://www.hearybros.com>



CNHB-95
Thru Roof Connector

Adjustable for roof thickness to 10" (250mm).
Threaded rod is 1/2" (13mm) x 18" (460mm) solid stainless steel with copper bolt pressure-type cable connectors at each end. Includes 2 (two) neoprene washers, 2 (two) stainless steel washers and 2 (two) stainless steel nuts.
Longer rods furnished upon request.

ANHB-95
Thru Roof Connector
Same as above in Aluminum cable connector.

PNHB-95
Thru Roof Connector
Same as above in Corrosion resistant cable connector.



CNHB-95D
Thru Roof Connector

Adjustable for roof thickness to 10" (250mm).
Threaded rod is 1/2" (13mm) x 18" (460mm) solid stainless steel with copper bolt pressure-type cable connectors at each end. Includes 2 (two) neoprene washers, 2 (two) stainless steel washers and 2 (two) stainless steel nuts.
Longer rods furnished upon request.

ANHB-95D
Thru Roof Connector
Same as above in Aluminum cable connector.

PNHB-95D
Thru Roof Connector
Same as above in Corrosion Resistant cable connector.



CNHB-94D
Thru-Wall Connector

Stainless steel Thru-Wall Connector with 2 (two) copper bolt pressure-type cable connector at each end of 18" (460mm) threaded rod. Includes 4 (four sets of stainless steel nuts and washers for tightening to wall. Recommended for thru-wall connections. State size of conductor when ordering.

ANHB-94D
Thru-Wall Connector
Same as above in Aluminum.

PNHB-94D
Thru-Wall Connector
Same as above in Corrosion Resistant.

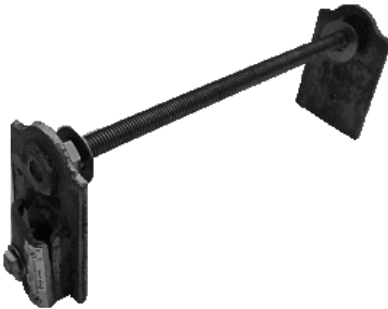

CNHB-94
Thru-Wall Connector

Stainless steel Thru-Wall Connector with 2 (two) cast bronze bolt pressure-type cable connector at each end of 18" (460mm) threaded rod. Includes 4 (four) sets of stainless steel nuts and washers for tightening to wall. Recommended for thru-wall connections. State size of conductor when ordering.

ANHB-94
Thru-Wall Connector
Same as above in Aluminum cable connector.

PNHB-94
Thru-Wall Connector
Same as above in Corrosion Resistant cable connector.

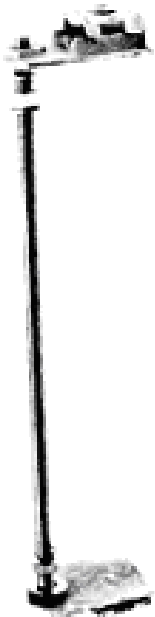

CNHB-119X

Thru Roof-Wall Connector

Stainless steel Thru-Roof (or Thru-Wall) Connector, with cast bronze bolt pressure-type cable connectors threaded to each end of 18" (460mm) long rod. Used for multi conductors connection at end of threaded rod. Recommended for through roof or through wall connections.

Longer rods available upon request.

Fits #2 thru 2/O conductor.

ANHB-119X

Thru Roof-Wall Connector

Same as above in Aluminum cable connector.

PNHB-119X

Thru Roof-Wall Connector

Same as above in Corrosion Resistant cable connector.

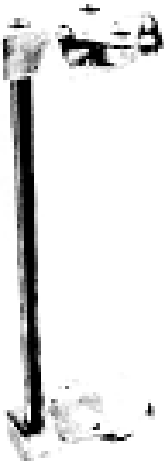

CNHB-120X

Thru Roof-Wall Connector

Same as HB-119X except fits larger conductors.

Fits 2/O thru 4/O conductor.

ANHB-120X

Thru Roof-Wall Connector

Same as above in Aluminum.

PNHB-120X

Thru Roof-Wall Connector

Same as above in Corrosion Resistant



SNHB-95XB

Economy Copper to Copper Connection

For top of thru the roof connection.

Size : $\frac{3}{4}$ " x $2\frac{1}{2}$ " (20mm x 65mm)

SNHB-95XA

Economy Aluminum to Aluminum Connection

Same as above in Aluminum.

HEARY BROTHERS LIGHTNING PROTECTION CO., INC.
11291 Moore Road, Springville, New York 14141 USA tel: 716-941-6141 toll free: 800-421-6141 fax: 716-941-3828
E-MAIL: sales@hearybros.com **INTERNET SITE:** <http://www.hearybros.com>

Section

9

FASTENERS AND ACCESSORIES

HEARY BROTHERS LIGHTNING PROTECTION CO., INC.
11291 Moore Road, Springville, New York 14141 USA tel: 716-941-6141 toll free: 800-421-6141 fax: 716-941-3828
E-MAIL: sales@hearybros.com **INTERNET SITE:** <http://www.hearybros.com>



CFHB-64

Cable Fastener with Metal Screw

A heavy copper loop, $\frac{5}{8}$ " (16mm) wide, complete with $\frac{1}{4}$ " (6mm) x $\frac{3}{4}$ " (20mm) stainless steel metal screw.
Fits cables through 4/O.

AFHB-64

Cable Fastener with Metal Screw

Same as above in Aluminum.

PFHB-64

Same as above in Corrosion Resistant.



CFHB-64XXD

Copper Conductor Standing Seam Cable Fastener

This cable fastener is for attaching cable to metal standing seam roofs. Clamp is rigidly attached to standing seam with 1 (one) stainless steel bolt. Clip holds cable in place.

Size: $1\frac{3}{4}$ " x 2" (45mm x 50mm)

AFHB-64XXD

Aluminum Standing Seam Cable Fastener

Same as above in Aluminum.

PFHB-64X

Corrosion Resistant Standing Seam Cable Fastener

Same as above in Corrosion Resistant.



CFHB-64R

Railing Cable Fastener

This cable fastener is for running cable along railings. An adjustable 1" (25mm) wide, copper bonding strap with clip style cable holder. Fits railing sizes through 4" (100mm) O.D.

Longer straps available upon request.

Also available in Aluminum (**AFHB-64R**) and Corrosion Resistant (**PFHB-64R**)

HEARY BROTHERS LIGHTNING PROTECTION CO., INC.
11291 Moore Road, Springville, New York 14141 USA tel: 716-941-6141 toll free: 800-421-6141 fax: 716-941-3628
E-MAIL: sales@hearybros.com **INTERNET SITE:** <http://www.hearybros.com>



SFHB-65
Stainless Steel Nail

2" (50mm) long nail for use with "one nail clip" #HB-67.



CFHB-66
Cable Fastener with Masonry Anchor

A heavy copper loop, $\frac{5}{8}$ " (16mm) wide, complete with a masonry anchor.

Fits cables through 2/O.



AFHB-66
Cable Fastener with Masonry Anchor
Same as above in Aluminum.

PFHB-66
Cable Fastener with Masonry Anchor
Same as above in Corrosion Resistant.



CFHB-67
Copper One Nail Clip

A heavy copper loop, $\frac{3}{8}$ " (10mm) wide.
Fits cables through 2/O.

AFHB-67
Aluminum One Nail Clip
Same as above in Aluminum.

HEARY BROTHERS LIGHTNING PROTECTION CO., INC.
11291 Moore Road, Springville, New York 14141 USA tel: 716-941-6141 toll free: 800-421-6141 fax: 716-941-3628
E-MAIL: sales@hearybros.com **INTERNET SITE:** <http://www.hearybros.com>



CFHB-70

Heavy Duty Bronze Cable Support

2 (two) stainless steel screw cable support with $\frac{3}{8}$ " (10mm) masonry anchor. Fits cables through 2/O.

AFHB-70

Heavy Duty Aluminum Cable Support

Same as above in Aluminum.

CFHB-71

Heavy Duty Bronze Cable Support

2 (two) stainless steel screw cable support with $\frac{1}{2}$ " (13mm) masonry anchor.

Fits cable through 4/O.

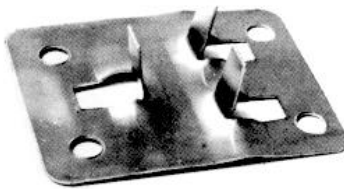

CFHB-72

Copper Adhesive Cable Fastener

This is a stamped brass no nail cable fastener for flat roofs. The attachment is permanently held in place with adhesive compound. Recommend for built-up or membrane roofs. Size: $2\frac{1}{2}$ " x $3\frac{1}{4}$ " (65mm x 83mm)

AFHB-72

Aluminum Adhesive Cable Fastener

Same as above in Aluminum.

HEARY BROTHERS LIGHTNING PROTECTION CO., INC.
11291 Moore Road, Springville, New York 14141 USA tel: 716-841-6141 toll free: 800-421-6141 fax: 716-941-3628
E-MAIL: sales@hearybros.com **INTERNET SITE:** <http://www.hearybros.com>



CFHB-72X

Copper Pan Type Cable Support

Copper pan type cable support is used in flat roof areas where there is a non-affixing surface. The pan base can be filled with cement or asphalt at the jobsite (not included).

Size: 1" x 7½" (25mm x 193mm)

AFHB-72X

Aluminum Pan Type Cable Support

Same as above in Aluminum.



CFHB-73

Cast Clip-Type Masonry Attachment

A cast bronze clip complete with masonry anchor.

Fits cables through 2/O.

Stainless steel machine screw or metal screw available upon request.

AFHB-73

Cast Clip-Type Masonry Attachment

Same as above in Aluminum.



SFHB-78X

Masonry Anchor

Drive-in with stainless steel drive pin.

HEARY BROTHERS LIGHTNING PROTECTION CO., INC.
11291 Macre Road, Springville, New York 14141 USA tel: 716-941-6141 toll free: 800-421-6141 fax: 716-941-3628
E-MAIL: sales@hearybros.com **INTERNET SITE:** <http://www.hearybros.com>



CFHB-108

Copper Bolt Hole Loop Guard Fastener

A heavy copper loop, 5/8" (16mm) wide with a 1/4" (6mm) bolt hole for fastening all ground guards.



GFHB-113

Guard Pipe Holder

A galvanized clip with masonry anchor and bolt for fastening PVC ground guard
#HB-108PVC



CFHB-117

Cast Bronze Adhesive Cable Fastener

Cast adhesive cable fastener with stainless steel screw and cast cable clamp.
Size: 2 3/4" (70mm) dia.

AFHB-117

Cast Aluminum Adhesive Cable Fastener

Same as above in Aluminum.



CFHB-201

Cable Fastener (with Stainless Steel Bolt)

Fastens conductor to rod, while simultaneously supporting the conductor.

HEARY BROTHERS LIGHTNING PROTECTION CO., INC.
11291 Moore Road, Springville, New York 14141 USA tel: 716-841-6141 toll free: 800-421-6141 fax: 716-841-3628
E-MAIL: sales@hearybros.com **INTERNET SITE:** <http://www.hearybros.com>

Section

10

ACCESSORIES

HEARY BROTHERS LIGHTNING PROTECTION CO., INC.
11291 Moore Road, Springville, New York 14141 USA tel: 716-941-6141 toll free: 800-421-6141 fax: 716-941-3628
E-MAIL: sales@hearybros.com **INTERNET SITE:** <http://www.hearybros.com>

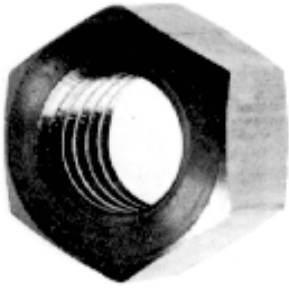

SFHB-74
Stainless Steel Nut

1/4" (6mm).
5/16" (8mm) and 1/2" (13mm) available upon request.



SFHB-80
Stainless Steel Machine Screw

Round Head
1/4" (6mm) x 3/4" (20mm)
Longer screws available up to 2" (50mm) upon request.



SFHB-80SS
Stainless Steel Metal Screw

Slotted Hex Washer head
1/4" (6mm) x 3/4" (20mm) long
Longer Screws available upon request.



SFHB-80ST
Stainless Steel Self-Tapping Screw

Slotted Hex Washer Head
1/4" (6mm) x 3/4" (20mm) long
Longer Screws available up to 2" (50mm) upon request.

HEARY BROTHERS LIGHTNING PROTECTION CO., INC.
11291 Moore Road, Springville, New York 14141 USA tel: 716-841-6141 toll free: 800-421-6141 fax: 716-941-3628
E-MAIL: sales@hearybros.com **INTERNET SITE:** <http://www.hearybros.com>



SFHB-81 ST

Stainless Steel Self Tapping Screw

Fine Thread, Slotted Hex Washer Head
1/4" (6mm) x 1 1/4" (32mm) long
Longer Screws available upon request.

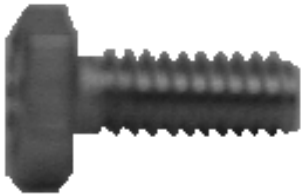

SFHB-81

Stainless Steel Bolt

Hex Head
1/4" (6mm) x 3/4" (20mm)
Longer Bolts available up to 2" (50mm) upon request.



SFHB-84

Stainless Steel Washer

5/16" (8mm) dia. hole
Larger sizes available upon request.

HEARY BROTHERS LIGHTNING PROTECTION CO., INC.
11291 Moore Road, Springville, New York 14141 USA tel: 716-941-6141 toll free: 800-421-6141 fax: 716-941-3828

E-MAIL: sales@hearybros.com **INTERNET SITE:** <http://www.hearybros.com>

Section

11

GROUNDING

HEARY BROTHERS LIGHTNING PROTECTION CO., INC.
11291 Moore Road, Springville, New York 14141 USA tel: 716-941-6141 toll free: 800-421-6141 fax: 716-941-3828
E-MAIL: sales@hearybros.com **INTERNET SITE:** <http://www.hearybros.com>

GROUND RODS



CGHB-106GR8	<i>Copper Bond 5/8" x 8'-0" (16mm x 2400mm)</i>
CGHB-106GR	<i>Copper Bond 5/8" x 10'-0" (16mm x 3000mm)</i>
CGHB-107GR8	<i>Copper Bond 3/4" x 8'-0" (20mm x 2400mm)</i>
CGHB-107GR	<i>Copper bond 3/4" x 10'-0" (20mm x 3000mm)</i>

Sectional Ground Rods

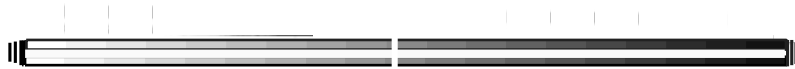

For when additional length ground rods are required.
Each sectional rod is 10 ft. (3000mm) long, threaded at each end and includes a ground rod coupler.

CGHB-106XGR	<i>5/8" (16mm) Copper Bond section rod with coupler.</i>
CGHB-107XGR	<i>3/4" (20mm) Copper Bond section rod with coupler.</i>



CGHB-108XGR	<i>Copper Ground Guard. 3/4" x 8'-0" (20mm x 2400mm)</i> Copper Pipe complete with 3 (three) guard fasteners # CGHB-108C.
CGHB-108PVC	<i>PVC Ground Guard. 3/4" x 8'-0" (20mm x 2400mm)</i> PVC pipe complete with 3 (three) guard fasteners # CGHB-108C.

HEARY BROTHERS LIGHTNING PROTECTION CO., INC.
11291 Moore Road, Springville, New York 14141 USA tel: 716-841-6141 toll free: 800-421-6141 fax: 716-841-3628
E-MAIL: sales@hearybros.com **INTERNET SITE:** <http://www.hearybros.com>

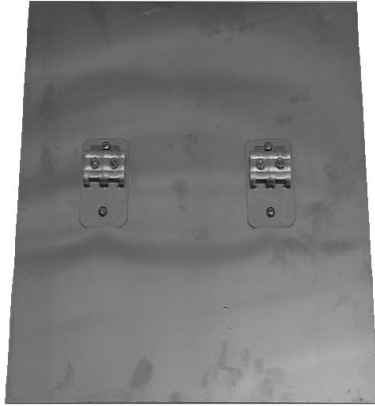

CGHB-158
Ground Plate
18" x 18" x 20 gauge
(460mm x 460mm), pure copper

CGHB-158X
Ground Plate
24" x 24" x 20 gauge
(600mm x 600mm), pure copper

CGHB-159
Ground Plate
36" x 36" x 20 gauge
(900mm x 900mm), pure copper



CGHB-57DGR
Ground Rod Clamp

A parallel clamp with 2 stainless steel bolts and nuts. This clamp is adjustable to fit all sizes of cables. Will also fit ground rods up to 1" (25mm) dia..
Size: 1½" x 2" (40mm x 50mm)



CGHB-111
Ground Rod Clamp

Bronze cast with two stainless steel bolts, fits ½" (13mm) and ⅝" (16mm) dia. ground rods.
Size: 2" x 2" (50mm x 50mm)

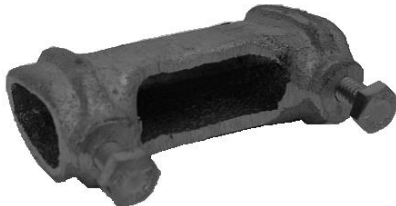

CGHB-112
Ground Rod Clamp

Bronze cast with two stainless steel bolts, fits ¾" (20mm) dia. ground rod.
Size: 1⅞" x 3½" (48mm x 90mm)

GROUNDING



HB-190 Cylinder Type Reservoir Ground.
Cylinder is 4" (100mm) diameter, 24" (600mm) long.



HB-203 4-Wing Grounding Plate
3 1/2" x 18" x 20 gauge
(90mm x 460mm).

CGHB-57B By-Pass Ground Rod Connector

Copper connector with 4 (four) stainless steel bolts. For connecting down cable and perimeter counterpoise cable to ground rod. Fits ground rods through 3/4" (20mm) dia. and cable through 4/0
Size: 2 1/2" x 2 1/2" (62.5mm x 62.5mm)



HB-206 Heavy Duty By-Pass Ground Rod Connector

Cast bronze connector with 2 (two) stainless steel bolts. For connecting down cable and perimeter counterpoise cable to ground rod. Fits ground rods through 3/4" (20mm) dia. and cables through 4/0.
Size: 1 3/4" x 2 1/4" (44mm x 60mm)

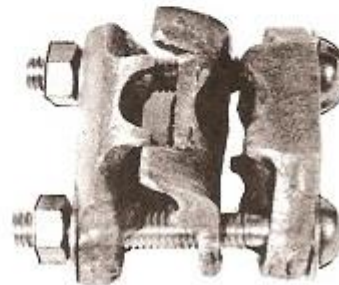

HB-207 Heavy Duty Large By-Pass Ground Rod Connector

Cast bronze connector with 2 (two) stainless steel bolts. For connecting down cable and perimeter counterpoise cable to ground rod. Fits ground rods through 1" (25mm) dia. cables from 4/0 to 500 MCM.
Size: 2" x 2 3/4" (50mm x 70mm)

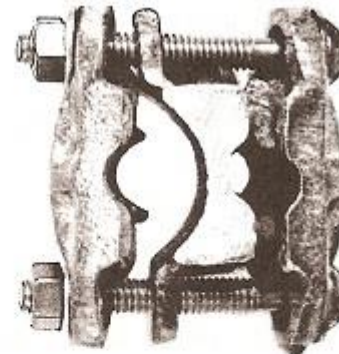

HEARY BROTHERS LIGHTNING PROTECTION CO., INC.
11291 Macro Road, Springville, New York 14141 USA tel: 716-941-6141 toll free: 800-421-6141 fax: 716-941-3628
E-MAIL: sales@hearybros.com INTERNET SITE: <http://www.hearybros.com>

GROUNDING

HB-TWC1212 Test Well (without cover)
 Lightweight, high strength, polymer reinforced test well.
 Approx. size: 12"x12"x12" (300 x 300x 300)

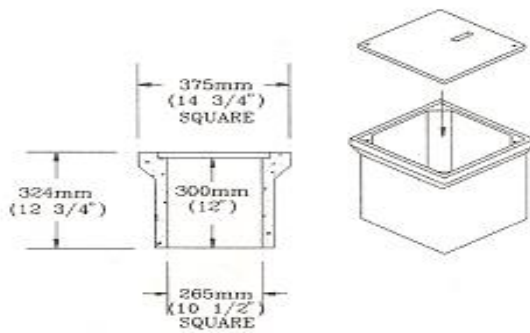
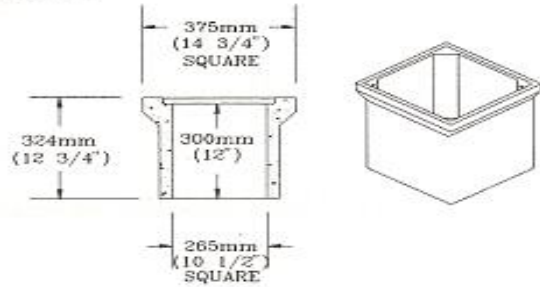

HB-TWC1212CC Test Well (with cover)
 Lightweight, high strength, polymer reinforced test well with cover.
 Approx. size: 12"x12"x12" (300 x 300 x 300)

HEARY BROTHERS LIGHTNING PROTECTION CO., INC.
 11291 Moore Road, Springville, New York 14141 USA tel: 716-941-6141 toll free: 800-421-6141 fax: 716-941-3628
E-MAIL: sales@hearybros.com **INTERNET SITE:** <http://www.hearybros.com>

GROUNDING

Electrical Grounding Wires

Concentric Copper Cable

HB-1/0C	105,600CM	320 lbs. per 1000 ft. (52mm ² , 475g/m)
HB- 2/0C	133,100CM	420 lbs. per 1000 ft. (67mm ² , 625g/m)
HB-3/0C	167,800CM	520 lbs. per 1000 ft. (85mm ² , 775g/m)
HB-4/0C	211,600CM	660 lbs. per 1000 ft. (107mm ² , 980g/m)
HB-250MCM	250,000CM	750 lbs. per 1000 ft. (127mm ² , 1115g/m)
HB-500MCM	500,000CM	1544 lbs. per 1000 ft. (253mm ² , 2300g/m)



SEE CONDUCTOR SECTION FOR ADDITIONAL CONDUCTORS AVAILABLE

HEARY BROTHERS LIGHTNING PROTECTION CO., INC.

11291 Moore Road, Springville, New York 14141 USA tel: 716-941-6141 toll free: 800-421-6141 fax: 716-941-3828

E-MAIL: sales@hearybros.com INTERNET SITE: <http://www.hearybros.com>















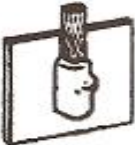





Section

12

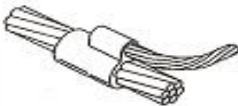
EXOTHERMIC WELDS

HEARY BROTHERS LIGHTNING PROTECTION CO., INC.
11291 Moore Road, Springville, New York 14141 USA tel: 716-941-6141 toll free: 800-421-6141 fax: 716-941-3828
E-MAIL: sales@hearybros.com **INTERNET SITE:** <http://www.hearybros.com>

CADWELD®
Exothermic Connections
COPPER TO COPPER
COPPER TO STEEL
COPPER TO REINFORCING BARS

			
HB-GR	HB-GT	HB-GY	HB-HX
			
HB-VF	HB-VS	HB-HB	HB-HA
			
HB-TA	HB-SS	HB-XA	HB-LA
			
HB-GB	HB-RJ	HB-PC	HB-PT
			
HB-RY	HB-RX	HB-VV	HB-RR

***ADDITIONAL CADWELD® CONNECTIONS AVAILABLE CALL TOLL FREE 800: 421-6141

HEARY BROTHERS LIGHTNING PROTECTION CO., INC.
 11291 Moore Road, Springville, New York 14141 USA tel: 716-941-6141 toll free: 800-421-6141 fax: 716-941-3628
E-MAIL: sales@hearybros.com **INTERNET SITE:** <http://www.hearybros.com>

Section

13

HEAVY DUTY STACK EQUIPMENT

HEARY BROTHERS LIGHTNING PROTECTION CO., INC.
11291 Moore Road, Springville, New York 14141 USA tel: 716-941-6141 toll free: 800-421-6141 fax: 716-941-3828

E-MAIL: sales@hearybros.com INTERNET SITE: <http://www.hearybros.com>

HEAVY DUTY STACK EQUIPMENT AIR TERMINALS

All air terminals have tapered points and threaded ends for adapting to air terminal bases.

Air Terminals-- Solid Stainless Steel

- HB-130SS -- 5/8" x 18" (16mm x 460mm)
- HB-131SS -- 5/8" x 2ft. (16mm x 600mm)
- HB-132SS -- 5/8" x 3ft. (16mm x 900mm)
- HB-133SS -- 5/8" x 4ft. (16mm x 1200mm)
- HB-134SS -- 5/8" x 5ft. (16mm x 1525mm)
- HB-135SS -- 5/8" x 6ft. (16mm x 1800mm)
- HB-136SS -- 5/8" x 7ft. (16mm x 2130mm)
- HB-137SS -- 5/8" x 8ft. (16mm x 2400mm)

Air Terminals--Bare Solid Copper

- HB-138C -- 5/8" x 18" (16mm x 460mm)
- HB-139C -- 5/8" x 2ft. (16mm x 600mm)
- HB-140C -- 5/8" x 3ft. (16mm x 900mm)
- HB-141C -- 5/8" x 4ft. (16mm x 1200mm)
- HB-142C -- 5/8" x 5ft. (16mm x 1525mm)
- HB-143C -- 5/8" x 6ft. (16mm x 1800mm)
- HB-144C -- 5/8" x 7ft. (16mm x 2130mm)
- HB-145C -- 5/8" x 8ft. (16mm x 2400mm)

NOTE:

- (1) All components on the upper 25ft.(7620mm) of heavy duty stacks must be corrosion resistant copper or stainless steel.
- (2) Corrosion Resistant air terminals up to 4ft.(1200mm) available upon request.
- (3) Additional length air terminals available upon request.



HEARY BROTHERS LIGHTNING PROTECTION CO., INC.
11291 Moore Road, Springville, New York 14141 USA tel: 716-941-6141 toll free: 800-421-6141 fax: 716-941-3828

E-MAIL: sales@hearybros.com INTERNET SITE: <http://www.hearybros.com>

**HEAVY DUTY STACK EQUIPMENT
AIR TERMINAL BASES**

4-way Side Mount Base
corrosion resistant bronze
HB-146CR (with threaded stud)
HB-147CR (with masonry anchor)

4-way Side Mount Base
bare bronze
HB-146C (with threaded stud)
HB-147C (with masonry anchor)

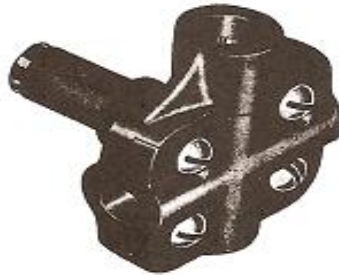
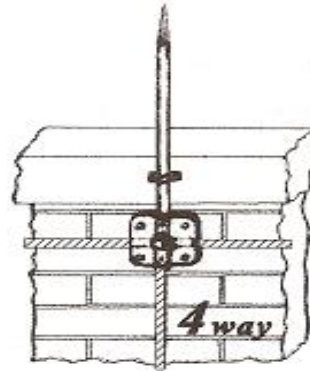

3-way Side Mount Base
corrosion resistant bronze
HB-149CR (with threaded stud)
HB-150CR (with masonry anchor)

3-way Side Mount Base
bare bronze
HB-149C (with threaded stud)
HB-150C (with masonry anchor)

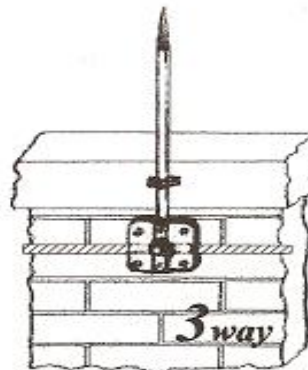

HEARY BROTHERS LIGHTNING PROTECTION CO., INC.
11291 Moore Road, Springville, New York 14141 USA tel: 716-941-6141 toll free: 800-421-6141 fax: 716-941-3828

E-MAIL: sales@hearybros.com **INTERNET SITE:** <http://www.hearybros.com>

**HEAVY DUTY STACK EQUIPMENT
AIR TERMINAL BASES**

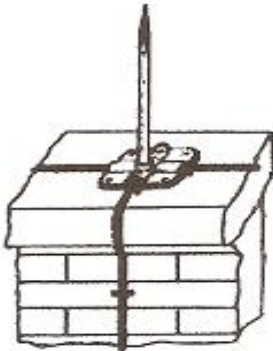

4-way

4-way Top Mount Base
corrosion resistant bronze
HB-152CR (with threaded stud)
HB-153CR (with masonry anchor)

4-way Top Mount Base
bare bronze
HB-152C (with threaded stud)
HB-153C (with masonry anchor)

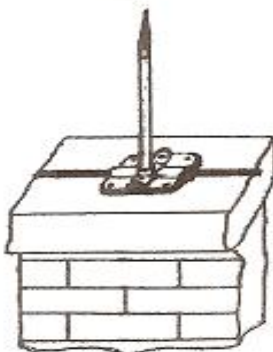

3-way

3-way Top Mount Base
corrosion resistant bronze
HB-155CR (with threaded stud)
HB-156CR (with masonry anchor)

3-way Top Mount Base
bare bronze
HB-155C (with threaded stud)
HB-156C (with masonry anchor)

HEARY BROTHERS LIGHTNING PROTECTION CO., INC.
11291 Moore Road, Springville, New York 14141 USA tel: 716-941-6141 toll free: 800-421-6141 fax: 716-941-3828

E-MAIL: sales@hearybros.com **INTERNET SITE:** <http://www.hearybros.com>

HEAVY DUTY STACK EQUIPMENT AIR TERMINAL BASES AND CONDUCTORS

HB-148CR Economy Stack Base
Corrosion resistant, Economy Stack Base.

HB-148C Same as above except in Copper.

Order air terminals from Heavy Duty Stack
Equipment--Air Terminal Section



HB-28-14C Copper Cable
Rope Lay construction with 28 strands of 14 gauge
copper wires. Weight 375 lbs. per 1000 feet
(1.628mm, 558g/m).

HB-28-14CR Corrosion Resistant Copper Cable
Same as Above, except Corrosion Resistant



HB-2/0C Copper Cable
Rope Lay construction with 28 strands of 13 gauge copper
wires. Weight 420 lbs. per 1000ft.
(1.828mm, 625g/m).

HB-2/0CR Corrosion Resistant Copper Cable
Same as Above, except Corrosion Resistant



HB-4/0C Heavy Duty Copper Cable
Concentric Wound construction with 19 strands of
10 gauge copper wires. Weight 660 lbs. per 1000ft.
(2.588mm, 980g/m).

HB-4/0CR Corrosion Resistant Copper Cable
Same as Above, except Corrosion Resistant



**Stainless steel conductor available upon request

**SEE CONDUCTOR SECTION AND GROUNDING SECTION FOR ADDITIONAL CONDUCTORS

HEARY BROTHERS LIGHTNING PROTECTION CO., INC.
11291 Moore Road, Springville, New York 14141 USA tel: 716-941-6141 toll free: 800-421-6141 fax: 716-941-3828

E-MAIL: sales@hearybros.com INTERNET SITE: <http://www.hearybros.com>

HEAVY DUTY STACK EQUIPMENT CONNECTORS

HB-97C Copper Strap Pipe Clamp

An adjustable 2" (50mm) wide, copper bonding strap with cast bolt-type pressure cable connector. Fits iron pipe sizes through 4" (100mm) O.D. Longer straps available upon request.

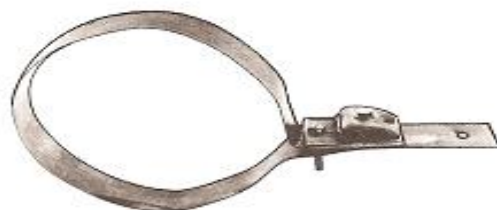

HB-100XC Copper Strap Pipe Clamp

An adjustable 1" (25mm) wide, copper bonding strap with cast bolt-type pressure cable connector. Fits iron pipes through 4" (100mm) O.D. Longer straps available upon request.



HB-154CR Heavy Duty Cable Splicer

Corrosion Resistant bronze, sleeve type splicer for cables through 2/0, includes 4 stainless steel screws.

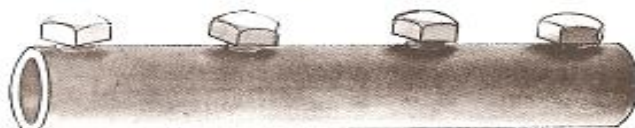

HB-160B Large One Bolt Bonding Lug

Cast copper, for bonding metal bodies.

HB-160BA Large One Bolt Bonding Lug

Same as above in Aluminum.



HB-183CR Point to cap connector Corrosion Resistant



HEARY BROTHERS LIGHTNING PROTECTION CO., INC.
11291 Macrae Road, Springville, New York 14141 USA tel: 716-941-6141 toll free: 800-421-6141 fax: 716-941-3628

E-MAIL: sales@hearybros.com INTERNET SITE: <http://www.hearybros.com>

HEAVY DUTY STACK EQUIPMENT CONNECTORS

HB-185CR Point Support
Corrosion Resistant Bronze
with masonry anchor.

HB-186CR Point Support
Corrosion Resistant Bronze
with threaded stud.



Masonry Anchor
#HB-185CR



Threaded Stud
#HB-186CR

HEARY BROTHERS LIGHTNING PROTECTION CO., INC.
11291 Moore Road, Springville, New York 14141 USA tel: 716-941-6141 toll free: 800-421-6141 fax: 716-941-3828

E-MAIL: sales@hearybros.com **INTERNET SITE:** <http://www.hearybros.com>